

ENGLISH



Canon

PowerShot S400  
DIGITAL ELPH

DIGITAL  
IXUS 400

# Camera User Guide



Canon

Canon DIGITAL CAMERA  
PowerShot S400  
DIGITAL ELPH  
DIGITAL  
IXUS 400

Camera User Guide

## DiGiC

- Please read the *Read This First* section (p. 7).
- Please refer to the *Software Starter Guide* for information on installing the software and downloading images.
- Please also read the printer user guide included with your Canon printer.

Exif Print



# Flowchart and Reference Guides

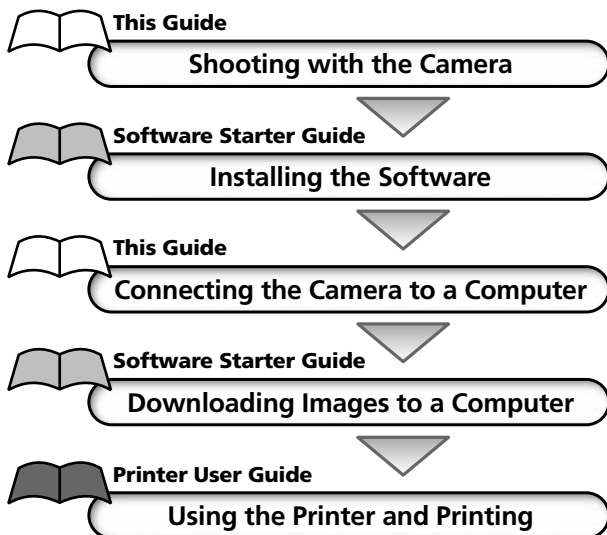

## Precautions

This digital camera is designed to perform optimally when used with genuine Canon-brand digital camera accessories ("Canon Brand Accessories").

You may use non-Canon brand accessories with this digital camera. However, Canon makes no warranties concerning, and is not responsible for damages resulting from, use of non-Canon brand accessories.

## Camera Body Temperature

If your camera is used for prolonged periods, the camera body may become warm. Please be aware of this and take care when operating the camera for an extended period.

## About the LCD Monitor

The LCD monitor is produced with extremely high-precision manufacturing techniques. More than 99.99% of the pixels operate to specification. Less than 0.01% of the pixels may occasionally misfire or appear as red or black dots. This has no effect on the recorded image and does not constitute a malfunction.

## Video Format





Please set the camera's video signal format to the one used in your region before using it with a TV monitor (p. 121).

## Charging the Date/Time Battery

- The camera has a built-in rechargeable lithium battery that maintains the date, time and other camera settings. This battery recharges when the main battery pack is inserted into the camera. When you first purchase the camera, place a charged battery pack in it or use the AC adapter kit (sold separately) for at least 4 hours to charge the date/time battery. It will charge even when the camera power is set to Off.
- If the Date/Time menu appears when the camera power is turned on, it means that the date/time battery charge is depleted. Recharge it as described above.

## About This Guide

### Conventions Used in the Text

Icons on the right end of title bars show the applicable operating modes. As in the example below, the mode dial should be set to , ,  or .

 **Using the Self-timer**



White buttons indicate the button that will be pushed in the particular procedure. In the example here, for instance, you should press the **MENU** button.



This mark denotes issues that may affect the camera's operation.



This mark denotes additional topics that complement the basic operating procedures.

### Question? Look Here First

- How do I navigate the Menu?  
**Selecting Menus and Settings (p. 38)**
- What settings are available under each function?  
and  
Will my settings remain in effect even after I've turned the camera off?  
**Functions Available in Each Shooting Mode (p. 160)**
- How do I go about printing?  
**About Printing (p. 98)**
- What functions are available through the menu?  
**FUNC. Menu (p. 126)**  
**Rec. Menu (p. 127)**  
**Play Menu (p. 129)**  
**Set up Menu (p. 130)**  
**My Camera Menu (p. 133)**

# Table of Contents

Items marked with  are lists or charts that summarize camera functions or procedures.

## Read This First

Please Read .....	7
Safety Precautions .....	7
Preventing Malfunctions .....	11

## Quick Start Section

Quick Start Section .....	12
---------------------------	----

## Components Guide

Front View .....	14
Back View .....	15
Operation Panel .....	16
Indicators .....	17

## Preparing the Camera

Charging the Battery Pack .....	18
Installing the Battery Pack .....	20
Installing a CF Card .....	22
Setting the Date and Time .....	23
Setting the Language .....	25







## Basic Functions

Turning the Power On/Off .....	26
Switching between Shooting/Replay .....	28
Using the LCD Monitor .....	29
Using the Viewfinder .....	34
Pressing the Shutter Button .....	35
Using the Zoom .....	37
Selecting Menus and Settings .....	38
Selecting Menus and Setting (Cont'd) .....	40
Menu Settings and Factory Defaults .....	42



## Customizing the Camera (My Camera Settings)

Changing My Camera Settings .....	45
Registering My Camera Settings .....	46

## Shooting

Selecting a Shooting Mode .....	49
Reviewing an Image Right after Shooting .....	50
Changing Resolution/Compression Settings .....	51
 Using the Flash .....	53
 /  Shooting Close-Ups/Infinity Shots .....	55
Using the Digital Zoom .....	56
 Continuous Shooting .....	57
 Using the Self-timer .....	58
Shooting in Stitch Assist Mode .....	59
Shooting a Movie .....	62
Locking the Focus (AF Lock) .....	64
Locking the Exposure Setting (AE Lock) .....	66
Locking the Flash Exposure Setting (FE Lock) .....	67
Switching between Autofocus Modes .....	68
 Switching between Light Metering Modes .....	69
Adjusting the Exposure Compensation .....	70
Shooting in Long Shutter Mode .....	71
Setting the White Balance .....	73
Changing the Photo Effect .....	76
Adjusting the ISO Speed .....	77
Setting the Auto Rotate Function .....	78
Resetting the File Number .....	79

## Replaying

Displaying Images Individually .....	80
 Magnifying Images .....	81
 Viewing Images in Sets of Nine (Index Replay) .....	82
Viewing Movies .....	83
Editing Movies .....	85

Rotating Images in the Display .....	87
Attaching Sound Memos to Images .....	88
Automated Playback (Slide Shows) .....	90
Protecting Images .....	94

## Erasing

 Erasing Single Images .....	95
Erasing All Images .....	96
Formatting CF Cards .....	97

## Printing

About Printing .....	98
Connecting a Printer .....	102
Printing .....	105
Setting the Print Settings (Direct Print Function) .....	107
Setting the DPOF Print Settings .....	111

## Image Transmission Settings (DPOF Transfer Order)

Selecting Images for Transferring .....	119
---	-----

## Shooting/Replaying with a TV

Shooting/Replaying with a TV .....	121
------------------------------------	-----

## Downloading Images to a Computer

Connecting the Camera to a Computer via the USB Cable .....	122
Downloading Directly from a CF Card .....	125

## Lists of Menu Options and Messages

FUNC. Menu .....	126
Rec. Menu .....	127
Play Menu .....	129
Set up Menu .....	130
My Camera Menu .....	133
Resetting Settings to Their Default Values .....	136
List of Messages .....	137

**Appendices**

Using an AC Adapter Kit (Sold Separately) .....	141
Using a Car Battery Charger (Optional) .....	142
Camera Care and Maintenance .....	143
Troubleshooting .....	144

**Specifications**

Specifications .....	148
----------------------	-----

**Index**

Index .....	154
-------------	-----

**List of Functions**

Functions Available in Each Shooting Mode .....	160
---	-----



# Read This First

## Please Read

### Test Shots

Before you try to photograph important subjects, we highly recommend that you shoot several trial images to confirm that the camera is operating and being operated correctly. Please note that Canon, its subsidiaries and affiliates, and its distributors are not liable for any consequential damages arising from any malfunction of a camera or accessory, including CompactFlash™ cards, that results in the failure of an image to be recorded or to be recorded in a format that is machine readable.

### Warning Against Copyright Infringement

Please note that Canon digital cameras are intended for personal use and should never be used in a manner that infringes upon or contravenes international or domestic copyright laws and regulations. Please be advised that in certain cases the copying of images from performances, exhibitions, or commercial properties by means of a camera or other device may contravene copyright or other legal rights even if the image was shot for personal use.

### Warranty Limitations

This camera's warranty is only effective in the country of sale. If a problem arises while the camera is in use abroad, please convey it back to the country of sale before proceeding with a warranty claim to a Canon Customer Support Help Desk.

**For Canon Customer Support contacts, please see the Canon Limited Warranty supplied with your camera.**

## Safety Precautions

- Before using the camera, please ensure that you read and understand the safety precautions described below. Always ensure that the camera is operated correctly.
- The safety precautions noted on the following pages are intended to instruct you in the safe and correct operation of the camera and its accessories to prevent injuries or damage to yourself, other persons and equipment.
- In the next few pages, the term "equipment" refers primarily to the camera and its power supply accessories, such as the battery charger and optional compact power adapter or car battery charger.

 **Warnings**

- Do not aim the camera directly into the sun or at other intense light sources that could injure your eyesight.

---

- Do not trigger the flash in close proximity to human or animal eyes. Exposure to the intense light produced by the flash may injure eyesight. In particular, remain at least one meter (39 inches) away from infants when using the flash.

---

- Store this equipment out of the reach of children and infants. Accidental damage to the camera or batteries by a child could result in serious injury. In addition, placement of the strap around the child's neck could result in asphyxiation.

---

- Do not attempt to disassemble or alter any part of the equipment that is not expressly described in this guide. Disassembly or alteration may result in high-voltage electrical shock. Internal inspections, alterations and repairs should be conducted by qualified service personnel authorized by your camera distributor or a Canon Customer Support Help Desk.

---

- To avoid the risk of high-voltage electrical shock, do not touch the flash portion of the camera if it has been damaged. Similarly, never touch internal portions of the equipment that become exposed as a result of damage. There is a risk of high-voltage electrical shock. Please take the first opportunity to consult your camera distributor or the closest Canon Customer Support Help Desk.

---

- Stop operating the equipment immediately if it emits smoke or noxious fumes. Failure to do so may result in fire or electrical shock. Immediately turn the camera's power off, remove the camera battery or unplug the power cable from the power outlet. Confirm that smoke or fume emissions have ceased. Please consult your camera distributor or the closest Canon Customer Support Help Desk.

---

- Stop operating the equipment if it is dropped or the casing is damaged. Failure to do so may result in fire or electrical shock. Immediately turn the camera's power off, remove the camera battery or unplug the power cable from the power outlet. Please consult your camera distributor or the closest Canon Customer Support Help Desk.

---

- 
- Do not allow the equipment to come into contact with, or become immersed in, water or other liquids. Do not allow liquids to enter the interior. The camera has not been waterproofed. If the exterior comes into contact with liquids or salt air, wipe it dry with a soft, absorbent cloth. If water or other foreign substances enter the interior, immediately turn the camera's power off and remove the camera battery or unplug the power cable from the power outlet. Continued use of the equipment may result in fire or electrical shock. Please consult your camera distributor or the closest Canon Customer Support Help Desk.
- 
- Do not use substances containing alcohol, benzene, thinners or other flammable substances to clean or maintain the equipment. The use of these substances may lead to fire.
- 
- Remove the power cable on a regular periodic basis and wipe away the dust and dirt that collects on the plug, the exterior of the electrical outlet and the surrounding area. In dusty, humid or greasy environments, the dust that collects around the plug over long periods of time may become saturated with humidity and short-circuit, leading to fire.
- 
- Do not cut, damage, alter or place heavy items on the power adapter cable. Any of these actions may cause an electrical short circuit, which may lead to fire or electrical shock.
- 
- Do not handle the power cable if your hands are wet. Handling it with wet hands may lead to electrical shock. When unplugging the cable, ensure that you hold the solid portion of the plug. Pulling on the flexible portion of the cable may damage or expose the wire and insulation, creating the potential for fires or electrical shocks.
- 
- Use of power sources not expressly recommended for this equipment may lead to overheating, distortion of the equipment, fire, electrical shock or other hazards. Use only the recommended power accessories.
- 
- Do not place the batteries near a heat source or expose them to direct flame or heat. Neither should you immerse them in water. Such exposure may damage the batteries and lead to the leakage of corrosive liquids, fire, electrical shock, explosion or serious injury.
- 
- Do not attempt to disassemble, alter or apply heat to the batteries. There is serious risk of injury due to an explosion. Immediately flush with water any area of the body - including the eyes and mouth, or clothing - that comes into contact with the inner contents of a battery. If the eyes or mouth contact these substances, immediately flush with water and seek medical assistance.
-

- 
- Avoid dropping or subjecting the batteries to severe impacts that could damage the casings. It could lead to leakage and injury.
- 
- Do not short-circuit the battery terminals with metallic objects, such as key holders. It could lead to overheating, burns and other injuries. Use the supplied terminal cover or battery case to transport or store the battery pack.
- 
- Before you discard a battery, cover the terminals with tape or other insulators to prevent direct contact with other objects. Contact with the metallic components of other materials in waste containers may lead to fire or explosions. Discard the batteries in specialized waste facilities if available in your area.
- 
- Use of batteries not expressly recommended for this equipment may cause explosions or leaks, resulting in fire, injury and damage to the surroundings. Use only recommended batteries and accessories.
- 
- Use the specified battery charger to charge Battery Pack NB-1LH or NB-1L. Use of other chargers may lead to overheating, distortion of the equipment, fire or electrical shock.
- 
- Disconnect the battery charger and compact power adapter from both the camera and the power outlet after recharging and when they are not in use to avoid fire and other hazards. Continuous use over a long period may cause a unit to overheat and distort, resulting in fire.
- 
- The camera terminal of the supplied compact power cord is designed for exclusive use with your camera. Do not use it with other products or batteries. There is a risk of fire and other hazards.
- 

### **Cautions**

- Avoid using, placing or storing the equipment in places subject to strong sunlight or high temperatures, such as the dashboard or trunk (boot) of a car. Exposure to intense sunlight and heat may cause the batteries to leak, overheat or explode, resulting in fire, burns or other injuries. High temperatures may also cause deformation of the casing. Ensure that there is good ventilation when using the compact power adapter to charge the battery pack or power the camera.
- 
- Do not store the equipment in humid or dusty areas. Storage in such areas could lead to fire, electrical shock or other damage.
- 
- Be careful not to bang the camera or subject it to strong impacts or shocks that could lead to injury or damage the equipment when wearing or holding it by the strap.
-

- 
- Be careful not to cover the flash with your fingers when shooting. In addition, do not touch the surface of the flash after taking several pictures in rapid succession. Either action could result in burns.
- 
- Do not operate the flash with dirt, dust or other items stuck to its lens. The resulting heat build-up could damage the flash.
- 
- If your camera is used for prolonged periods, the camera body may become warm. Please take care when operating the camera for extended periods as your hands may experience a burning sensation.
- 

## Preventing Malfunctions

### Avoid Strong Magnetic Fields

Never place the camera in close proximity to electric motors or other equipment generating strong electromagnetic fields. Exposure to strong magnetic fields may cause malfunctions or corrupt image data.

### Avoid Condensation Related Problems

Moving the equipment rapidly between hot and cold temperatures may cause condensation (water droplets) to form on its external and internal surfaces. You can avoid this by placing the equipment in an airtight, resealable plastic bag and letting it adjust to temperature changes slowly before removing it from the bag.

### If Condensation Forms Inside the Camera

Stop using the camera immediately if you detect condensation. Continued use may damage the equipment. Remove the CF card and battery or Compact Power Adapter (if connected) from the camera and wait until the moisture evaporates completely before resuming use.

### Extended Storage

When not using the camera for extended periods of time, remove the battery pack and store the equipment in a safe place. Storing the camera for extended periods with a battery pack installed will run down the battery pack and may damage the camera. Please note, however, that the date, time and other camera settings may reset to the default settings if the battery pack has been removed for more than three weeks. Follow the instructions in this guide to reset the desired settings.

## Quick Start Section

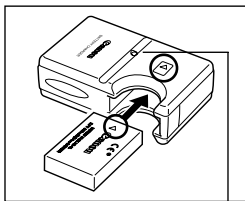

Charge Indicator

### ❶ Charge the Battery Pack (p. 18).

Place the battery pack in the battery charger and plug the charger into a power outlet. The charge indicator lights red while charging and changes to green when the battery pack is charged.

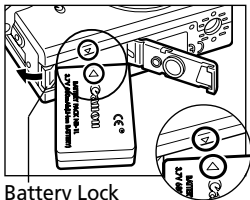

Battery Lock

### ❷ Install the Battery Pack (p. 20).

Slide the battery cover open and press the battery lock while you insert the battery pack. Insert the battery pack correctly by aligning the arrows on the camera and battery pack.

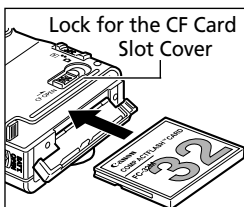

Lock for the CF Card Slot Cover

### ❸ Install the CF Card (p. 22).

Slide the lock on the CF card cover to open it and insert the CF card until the ejection button fully extends.

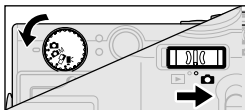

### ❹ Set the mode switch to and the shooting mode dial to (pp. 28, 49).

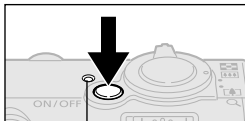

Power Lamp

### ❺ Turn on the Power (p. 26).

Press the ON/OFF button until the power lamp lights.

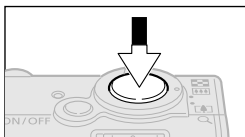

## 6 Focus (p. 35).

Aim the camera and lightly press (halfway) the shutter button. Two beeps will sound when the autofocus is set.

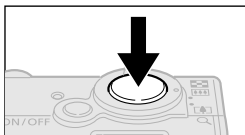

## 7 Shoot (p. 36).

Press the shutter button all the way. The shutter sound will sound once when the shot is complete.



## 8 View the Recorded Image (p. 50).

The recorded image displays for approximately 2 seconds. To continue displaying the image, keep the shutter button pressed or hold the shutter button until you press the **SET** button and then release both.



### To Immediately Delete the Displayed Image

1. Press the  button while the image is displayed.
2. Confirm that [Erase] is selected and press the **SET** button.



- Set the date and time if the Date/Time menu appears (p. 23).
- You can change the language in which menus are displayed (p. 25).
- To view the other images you have photographed, refer to the *Replaying* section (p. 80).
- After you finish using the camera, press the ON/OFF Button to shut the power off.

# Components Guide

## Front View

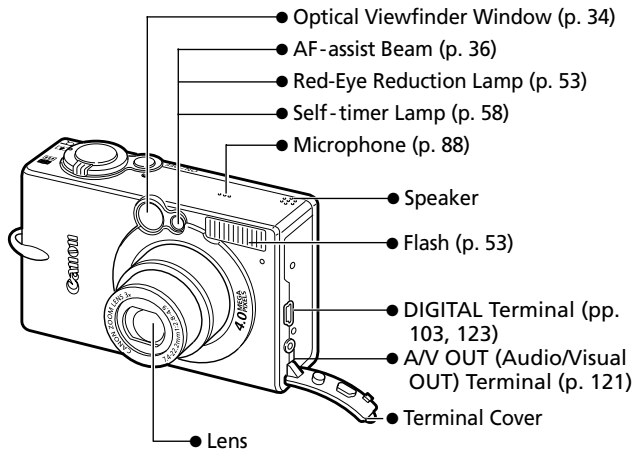

**The following cables are used to connect the camera to a computer or printer.**

- Computer (p. 123)  
USB Interface Cable IFC-300PCU (supplied with camera)
- Direct Print Function Compatible Printer (CP series, sold separately) (p. 102)  
Direct Interface Cable DIF-100 (supplied with printer)
- Direct Print Function Compatible Bubble Jet Printer  
(sold separately) (p. 103)  
Please refer to your Bubble Jet printer *Quick Start Guide*.

Please refer to the *System Map* supplied with the camera for direct print function compatible printers.



## Back View

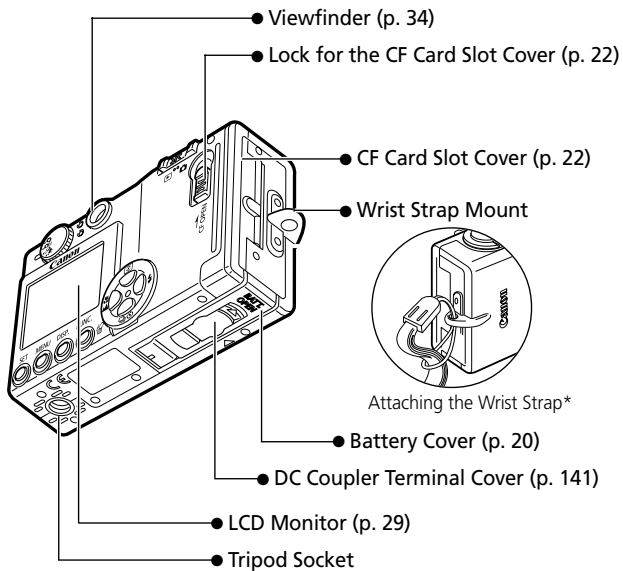

\* Be careful not to wave the camera about or catch it on other items when dangling it from the wrist strap.

## Operation Panel

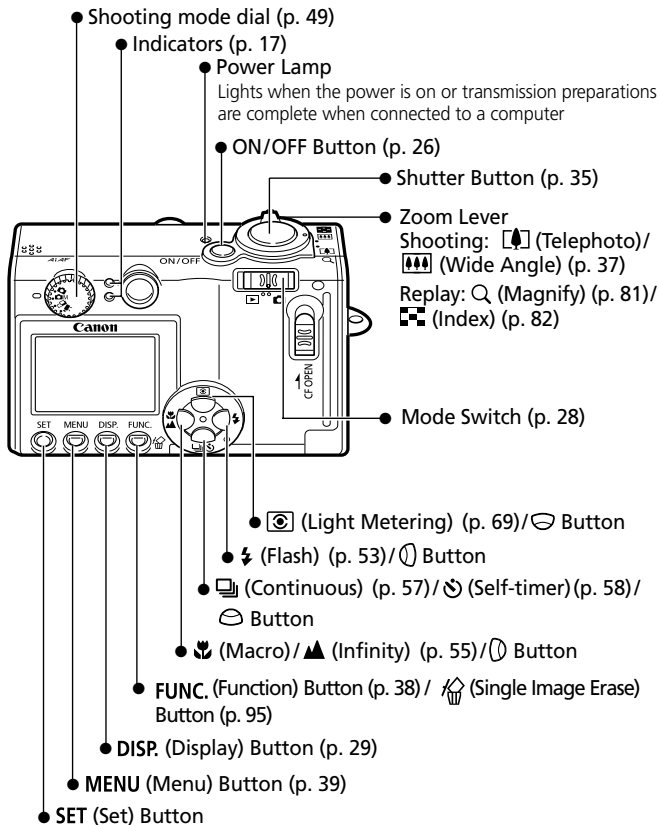

## Indicators

The indicators light or blink when the ON/OFF Button or shutter button is pressed.

### Upper Indicator

Green:	Ready to shoot
Blinking Green:	Recording to CF card / Reading CF card / Erasing from CF card / Transmitting data (during a computer connection)
Orange:	Ready to shoot with slow shutter speed (flash on)
Blinking Orange:	Ready to shoot but shutter speed is slow (camera shake warning)

### Lower Indicator

Yellow:	Macro mode / Infinity mode / Focus lock (Method 2, p. 64)
Blinking Yellow:	Focusing difficulty (1 beep sounds). Although you can press the shutter button, you are recommended to use the focus lock (p. 64).

## Preparing the Camera

### Charging the Battery Pack

Use the following procedures to charge the battery pack the first time you use the camera or when the "Change the battery pack" message displays.

**Battery charger model names and types vary by region.**

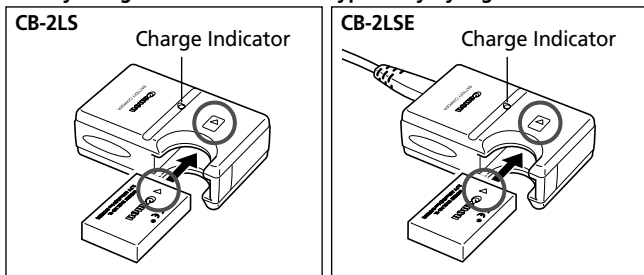

- Insert the battery pack all the way into the battery charger as shown and insert the charger's plug into a power outlet.
- Align the battery pack correctly with the arrows on it and the charger.
- The charge indicator will light red while the battery pack is charging. It will change to green when the charge is complete.
- After charging, unplug the battery charger and remove the battery pack.



To protect the battery pack and prolong its life, do not charge it for longer than 24 hours continuously.



- Since this is a lithium ion battery pack, you need not completely discharge it before recharging. It can be recharged at any point.
- It takes approximately 130 minutes to fully charge the battery pack from a fully discharged state (based on Canon's testing standard). Charging it within a temperature range of 5° to 40° C (41° to 104° F) is recommended.
- Charge times may vary according to the ambient temperature and the battery pack's charge state.
- See *Battery Capacity* (p. 150).
- You may hear a noise during charging. This is not a malfunction.

## Handling Precautions

- Keep the battery pack terminals ( $\oplus \oplus \ominus$ ) clean at all times. Dirty terminals may cause poor contact between the battery pack and camera. Polish the terminals with a tissue or a dry cloth before charging or using the battery pack.
- Do not rapidly overturn or wave the battery charger around when it contains the battery pack. The battery pack could fly out.
- At low temperatures, battery pack performance may be reduced and the low battery icon may appear earlier than usual. Under these conditions, resuscitate the battery pack by warming it in a pocket immediately before use. However, ensure that there are no metallic items in the pocket that could cause a short circuit, such as a key holder, etc.
- Do not place anything, such as tablecloths, carpets, bedding or cushions, on top of the battery charger while it is charging. Heat will build up and could result in a fire.
- Do not charge batteries other than Battery Pack NB-1LH or NB-1L (sold separately) in this charger.
- The battery pack continues to discharge a minimal portion of its power while installed in the camera, even with the power off, or in the charger. This will shorten battery life.
- Do not allow any metal objects such as keyrings to touch the "+" and "-" terminals (Fig. A), as this can damage the battery pack. To carry the battery pack or store it during periods of disuse, always replace the terminal cover (Fig. B) or place it in the supplied case and store it in a cool, dry place. Recharge it fully before using it again.

Fig. A



Fig. B



- Even charged battery packs continue to discharge naturally. You are advised to charge the battery on the day of use, or one day before, to ensure a full charge.
- Since storing a fully charged battery pack for long periods of time (about 1 year) can shorten its life cycle or affect performance, you are recommended to use the battery pack in the camera until it is completely discharged and to store it at normal temperature (23°C/ 73°F) or lower. If you do not use the battery pack for long periods of time, charge it fully and discharge it fully in the camera at least once a year before returning it to storage.
- If the performance of the battery pack diminishes substantially even when it is fully charged, its life has been exceeded and it should be replaced.

## Installing the Battery Pack

Install Battery Pack NB-1LH (supplied) as shown below. Battery Pack NB-1L (optional) can also be used with the camera.



Please recharge the battery pack (p. 18) before you use it for the first time.

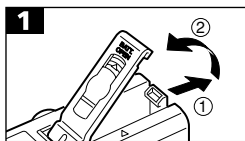

- Slide the battery cover in the direction of the arrows.

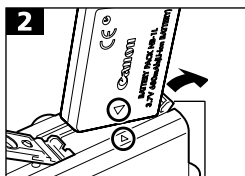

Battery Lock

- Press the battery lock while inserting the battery pack all the way in until the lock clicks.
- Insert the battery pack correctly by aligning the arrows on the camera and the battery pack.
- To remove the battery pack, press the battery lock and pull the battery pack out.

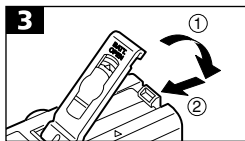

- Slide the battery cover closed.









- Do not turn off the power or open the battery cover while the camera's indicator blinks green. The camera is writing, reading, erasing or transmitting an image to or from the CF card.
- Remove the battery pack when the camera is not in use. Please note, however, that the date, time and other camera settings may reset to the default settings if the battery pack has been removed for more than three weeks.



Please use an AC Adapter Kit ACK500 (sold separately) for extended use of the camera (p. 141).

## Battery Pack Charge

The following icons and messages will display when the battery pack charge is low.

	<p>Battery pack charge is low. Recharge it as soon as possible before it is required for an extended period.</p> <p>When the LCD monitor is off, this icon will display when you press the , , , , , <b>DISP.</b>, <b>FUNC.</b> or  button (CAM mode).</p>
<p>Change the battery pack</p>	<p>Battery charge is insufficient to operate the camera. Replace the battery pack immediately.</p>



See *Battery Capacity* (p. 150).

## Installing a CF Card

Turn the camera power off and insert the CF card with the following procedures.

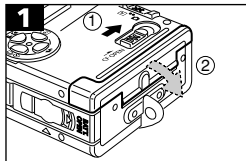

- Slide the lock up and open the CF card slot cover.

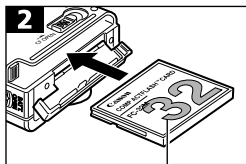

- Insert the CF card with its label facing upward until the CF card eject button fully extends. Close the CF card slot cover.

Label

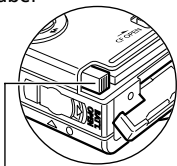

CF Card Eject Button



- Since the camera is writing, reading, erasing or transmitting data to or from the CF card when the indicator blinks green, never perform the following actions during this time. It could corrupt the image data.
  - Subject the camera body to vibration or shocks.
  - Turn the camera's power off, or open the battery cover or CF card slot cover.
- Please note that CF cards formatted with other manufacturers' cameras or a computer, or formatted or edited with application programs, may not operate correctly in the camera.
- You are recommended to use CF cards that have been formatted in your camera (p. 97). The card supplied with the camera may be used without further formatting.





See *CF Cards and Estimated Capacities* (p. 151).

## Handling Precautions for CF Cards

- CF cards are high-precision electronic devices. Do not bend them, apply force to them, or subject them to shocks or vibration.
- Do not attempt to disassemble or alter a CF card.
- Moving a CF card rapidly between temperature extremes will cause condensation to form in the card and lead to a malfunction. To avoid condensation, place the CF card in a sealed plastic bag before moving it into a different temperature zone and allow it to adjust slowly to the new temperature. If condensation forms on the CF card, store it at room temperature until the water droplets have evaporated naturally.
- Do not use or store CF cards in the following types of locations.
  - Locations subject to dust or sand
  - Locations subject to high humidity and high temperatures

## Setting the Date and Time

The Date/Time menu will appear the first time the camera power is turned on or whenever the built-in rechargeable lithium battery charge is low. Start from Step 3 to set the date and time.

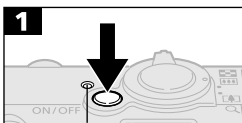



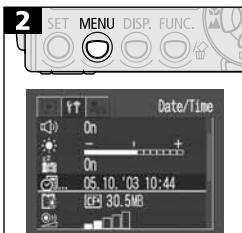



Power Lamp







- Press the ON/OFF button until the power lamp lights.

- Press the **MENU** button to display the Rec. or Play menu.

- Use the  or  button to select the  (Set up) menu.

- Use the  or  button to select .



- Use the  or  button to select a field (year, month, day, hour, minute and date format), and the  or  button to change its value.



- To put the settings into effect, press the **SET** button after setting the date format.



- Press the **MENU** button to redisplay the Rec. or Play screen.



- Please note that the date and time settings may reset to the default settings if the camera battery has been removed for more than three weeks. Reset them when this occurs.
- Setting the date and time settings does not cause the date/time stamp to appear on images.



- Charging the Date/Time Battery
  - The camera has a built-in rechargeable lithium battery for saving settings such as the date and time. This battery is recharged by the battery pack while it is in the camera. Right after purchasing the camera, leave a charged battery pack in the camera, or plug in AC Adapter Kit ACK500 (sold separately), for about 4 hours to charge the date/time battery. It will charge even when the camera's power switch is off.
  - If the Date/Time menu appears when the camera power is turned on, the date/time battery charge is low. Use the above method to recharge it.
- You can print the date on images (p. 107).

## Setting the Language

The language in which menus and messages are displayed can be selected with this function.

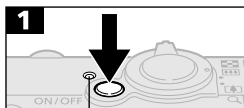

Power Lamp

- Press the **ON/OFF** button until the power lamp lights.



- Press the **MENU** button to display the Rec. or Play menu.

- Use the or button to select the (Set up) menu.

- Use the or button to select .



- Use the , , or button to select a language.



- Press the **MENU** button to redisplay the Rec. or Play screen.





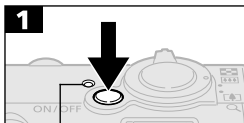

The Language menu can also be displayed in replay mode by holding down the **SET** button and pressing the **MENU** button. (This function cannot be used while a direct print compatible printer (CP series, optional) or the direct print compatible Bubble Jet Printer (optional) is connected to the camera or while replaying movies.)

## Basic Functions

### Turning the Power On/Off



Power Lamp

- Press the ON/OFF Button until the green power lamp lights.
  - The lens extends outward when the mode switch is set to .
  - The lens retracts approximately 1 minute after sliding the mode switch from  to .
  - When the mode switch is set to , the upper indicator beside the viewfinder will flash green and the LCD monitor will turn on.
- Press the ON/OFF Button again to turn off the power.



- The Date/Time menu will appear the first time the camera power is turned on or whenever the charge of the built-in rechargeable lithium date/time battery is low. Reset the date and time when this occurs (p. 23).
- If the Auto Power Down function activates, press the ON/OFF Button to restore power.
- The start-up sound will sound and the start-up image will display in the LCD monitor when the power is turned on. (To change the start-up sound and image, see pp. 27, 45, 133.)
- The start-up image does not display when the LCD monitor is turned off in shooting mode or when the camera is connected to a TV via the A/V OUT terminal.



- **Turning Off the Start-Up Sound and Start-Up Image**  
Hold the SET button down while turning on the power.

- **Auto Power Down Function**

This camera is equipped with an Auto Power Down function. The power will automatically shut down under the following circumstances when this function is set to [On]. Press the ON/OFF Button to restore power.

**Shooting Mode**

Powers down approximately 3 minutes after the last control is accessed on the camera. (The LCD monitor automatically turns off 3 minutes after the last control is accessed even if this function is set to [Off]. Press any button except the ON/OFF Button to turn the LCD monitor back on.)

**Replay Mode**

Powers down approximately 5 minutes after the last control is accessed on the camera.

**Connected to a Printer (optional)**

Powers down approximately 5 minutes after the last control is accessed on the camera or something is printed on a connected printer.

- **The Auto Power Down function will not activate during a slide show or while the camera is connected to a computer.**
  - **The camera's settings can be changed to turn off the Auto Power Down function (p. 131).**
-

## Switching between Shooting/Replay

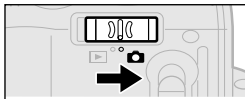



- **To Shoot Still Images (Shooting Mode)**  
Slide the mode switch to .



- **To Replay Images (Replay Mode)**  
Slide the mode switch to .
  - Recorded images can be printed when a printer (sold separately) is connected (p. 105).
  - Recorded images can be downloaded to and viewed with a computer when it is connected (p. 123).



- The  or  icon displays on the LCD monitor when a connection to a printer is opened.
- The LCD monitor shuts off while a computer is connected.

## Using the LCD Monitor

The LCD monitor can be used to compose images while shooting, adjust settings menus and replay images.



The image in the LCD monitor will darken in strong sunlight or bright light. This does not constitute a malfunction.

## Shooting Mode (📷 on the mode switch)



The LCD monitor turns on or changes the display mode as follows with each press of the **DISP.** button.

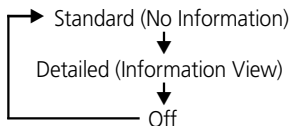

- The LCD monitor setting (On or Off) is saved by the camera when the power is turned off so that the same setting is automatically available when the power is turned on again. However, the setting may be lost when the power has been turned off after the “Change the battery pack” message has displayed, while the LCD monitor was on in shooting mode.
- In the 📷 or 📹 mode, the LCD monitor turns on regardless of its On/Off setting.

## Replay Mode (▶ on the mode switch)



- The LCD monitor will turn on when the mode switch is set to the ▶ position.
- In replay mode, pressing the **DISP.** button cycles the information view mode each time the button is pressed.

### Single Image Replay (p. 80)

Standard → Detailed → No Display



### Multi Image Replay (9 Images) (p. 82)

Standard ↔ No Display



## Information Displayed on the LCD Monitor

### Shooting Mode



When a shooting setting is changed, information about the settings displays on the LCD monitor for approximately 6 seconds even if the LCD monitor is set to Off or to the No Display mode. (It may not display under some circumstances, depending on the selected settings.)

You may set the flash, continuous mode, self-timer, macro, infinity and metering mode settings while this information is displayed.



- After you press the shutter button and take a shot, the recorded image appears on the LCD monitor for 2 to 10 seconds (1-second increments). It will continue to display if you press the **SET** button while it is shown on the screen. See *Changing the Review Duration* (p. 50).
- While a recorded image is displayed on the LCD monitor, you can check the exposure with the graph (see Histogram Function, p. 33) that shows the distribution of the brightness data. (Press the **DISP.** button if the histogram and other information is not shown) If the exposure requires adjustment, set the exposure compensation and reshoot.



A slow shutter speed has likely been selected because of insufficient lighting if the upper indicator flashes orange after the metering preparations are complete and the camera shake icon  displays in the LCD monitor. Set the flash to  or , or affix the camera to a tripod to shoot.

---

Spot AE Point Frame  
(CAM mode)

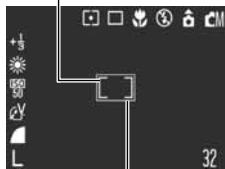

AF Frame  
(p. 68)

Recordable Images  
or Recordable  
Movie Time (sec.)

In movie mode, only the  
resolution shows (not  
compression).

## Information Displayed

	Shooting Mode	p. 49
	Exposure Compensation	p. 70
	Long Shutter Mode	p. 71
	White Balance	p. 73
	Photo Effects	p. 76
	Compression	p. 51
	Resolution	p. 51
	ISO Speed	p. 77
	Auto Rotate	p. 78
	Focus Lock	p. 64
	AE Lock	p. 66
	FE Lock	p. 67
	Flash	p. 53
	Shooting Method	p. 57-58
	Macro/Infinity	p. 55
	Metering Mode	p. 69
	Movie Recording	p. 62
	Digital Zoom	p. 56
	Camera Shake Warning	p. 31
	Low Battery	p. 21

- The icons in the shaded boxes above display regardless of the selected display mode.
- Zoom powers reflect the optical and digital zoom functions in combination. These figures display when the digital zoom is activated.

## Replay Mode (Standard Display)

File Number



Image Number

Shooting Date

The following information is displayed in standard display mode.

































	Compression (Still images)	p. 51
	Resolution (Still images)	p. 51
	WAVE Format Sound	p. 88
	Movie	p. 62
	Protection Status	p. 94

## Replay Mode (Detailed Display)







Histogram

In detailed display mode, the following supplementary information is displayed.

 ... 	Long Shutter Mode	p. 71
   	Shooting Mode	p. 49
 ...  ... 	Exposure Compensation	p. 70
      	White Balance	p. 73
    	Photo Effects	p. 76
   	ISO Speed	p. 77
	Flash	p. 53
 	Macro/Infinity	p. 55
  	Metering Method	p. 69
 	Resolution (Movie)	p. 51
Movie Length Shown on Movie Files		p. 62

The following information may also be displayed with some images.

	A sound file in a format other than the WAVE format is attached or the file format is not recognized.
	JPEG file with format not conforming to Design rule for Camera File System Standards
	RAW format file
	File with unrecognized format



- The image information may not display correctly if images shot with this camera are replayed on other cameras or images from other cameras are replayed on this camera.
- Histogram Function**

The histogram is a graph that allows you to judge the brightness of the recorded image. The greater the bias toward the left, the darker the image. The more it trends to the right, the brighter the image. If the image is dark, adjust the exposure to a positive value. Similarly, adjust the exposure to a negative value to darken a bright image (p. 70).

### Histogram Examples



Dark Image



Balanced Image



Bright Image

## Using the Viewfinder

The optical viewfinder can be used to conserve power by setting the LCD monitor to Off (p. 29) while shooting.

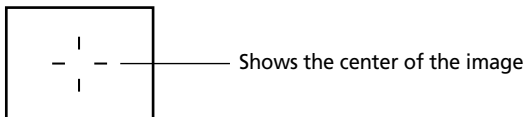

Viewfinder



- **About the Autofocus Function**

This camera employs AiAF (artificial intelligence autofocus) technology which uses a broad metering field to calculate the focal distance with high precision. It delivers a crisp focus even when the photographic subject is slightly off-center. The AiAF function can be turned off so that the autofocus is metered from a fixed AF frame at the center of the field to accommodate difficult shooting conditions (p. 68).

- **Image Seen in Viewfinder vs. Recorded Image**

Please note that the actual image may differ from the image seen in the optical viewfinder due to the physical separation between the viewfinder and lens. This is called the parallax phenomenon and is more noticeable the closer the subject is to the lens. In some cases, portions of images shot up close that appear in the viewfinder will not appear in the recorded image. Please use the LCD monitor to shoot images up close.

## Pressing the Shutter Button

The shutter button features a two-stage action.

### Pressing Halfway

Pressing halfway automatically sets the exposure, focus and white balance.

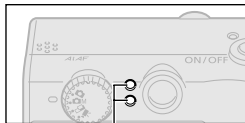
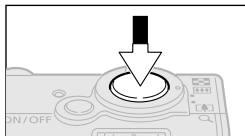

Indicator

#### • Indicator Status

##### Upper Indicator

- Green: Metering complete (two beeps sound)
- Orange: Flash will fire
- Blinking Orange: Camera shake warning/  
Insufficient exposure

##### Lower Indicator

- Yellow: Macro mode/Infinity mode/Focus lock  
(Method 2, p. 64)
- Blinking Yellow: Focusing difficulty\*  
(single beep sounds)

\* When the indicator blinks yellow, lock the focus before shooting (p. 64).

#### • AF Frame Status (LCD Monitor On)

##### AiAF On

- Green Frame: Metering complete (AF frame when focus achieved)

- No Frame: Focusing difficulty

##### AiAF Off (Center AF Frame)

- Green Frame: Metering complete

- Yellow Frame: Focusing difficulty

## Pressing Fully

Pressing the shutter button down fully activates the shutter and causes one shutter sound to sound.

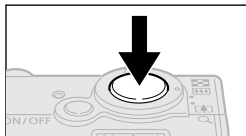

While the image is being recorded to the CF card, the indicator blinks green.



---

Shots cannot be taken while the flash is charging.

### AF-assist Beam

- The AF-assist Beam will sometimes emit when the shutter button is pressed halfway to assist focusing in certain conditions, i.e., dark conditions.
  - The AF-assist Beam can be turned off (p. 128).  
If animals are your subject, turn off the beam when shooting in the dark to avoid startling them. However, please keep in mind the following facts.
    - Turning the AF-assist beam off may make it more difficult for the camera to focus.
    - The red-eye reduction lamp may emit when the flash is set to red-eye reduction auto or slow-synchro, even if the AF-assist beam is turned off.
-

## Using the Zoom

The zoom can be adjusted from 36 mm to 108 mm in 35 mm film equivalent terms.

### Telephoto/ Wide Angle

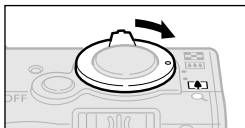

- Press the zoom lever toward  to zoom in (telephoto).

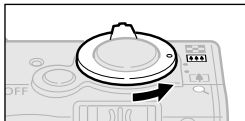

- Press the zoom lever toward  to zoom out (wide angle).

### Digital Zoom

When the LCD monitor is on, you can shoot with a combined optical and digital zoom factor of up to 11 (p. 56).



The digital zoom is unavailable in some modes (p. 161).



Please note that the image appears grainier, the more the image is digitally zoomed.

## Selecting Menus and Settings

Menus are used to adjust shooting and replay settings, as well as other camera settings like the Date/Time and sounds. Menus are displayed by pressing the **MENU** or **FUNC.** button according to the circumstances. Use the LCD monitor to perform the following procedures. See *Menu Settings and Factory Defaults* (p. 42) for the menu items and options.

### Selecting Menu Settings with the **FUNC.** Button (Shooting Mode only)

#### 1 Press the **FUNC.** button.

The icons of the items that can be adjusted appear at the LCD monitor's left edge.



#### 2 Use the or buttons to select an item.

#### 3 Use the or buttons to select an option.



- The icon changes to the icon of the selected option.
- Some menu items can only be selected after pressing the **SET** button to display the next menu. Press the **SET** button again to confirm the setting.

You can shoot right after performing these steps. The menu displays again after the shot, allowing you to change the settings easily.

#### 4 Press the **FUNC.** button.

The menu will close.



## Selecting Menu Settings with the MENU Button

### 1 Press the MENU button.

A menu will display.



Mode Switch Set to M

Mode Switch Set to

\*The menu will appear slightly different when the shooting mode dial is set to , , or .

### 2 Use the or buttons to select the Rec./Play, Set up, or My Camera menu.

### 3 Use the or buttons to select a menu item.



- Use the or buttons to select an option in the Rec. or Set up menu (some items only) and the My Camera menu.





- In the Play or Set up menu (some items only), you must press the **SET** button to access a submenu.

### 5 Press the MENU button.

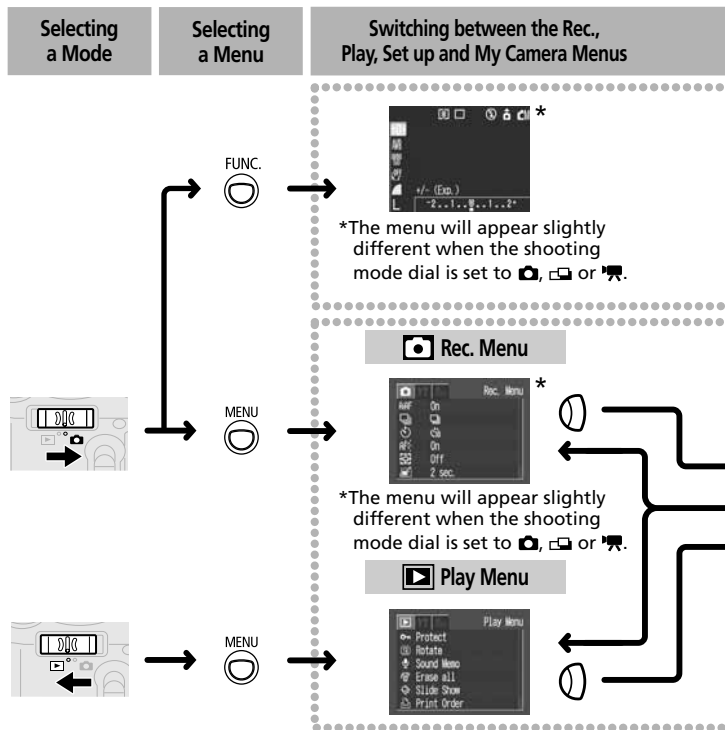

The menu will close.

## Selecting Menus and Settings (Cont'd)

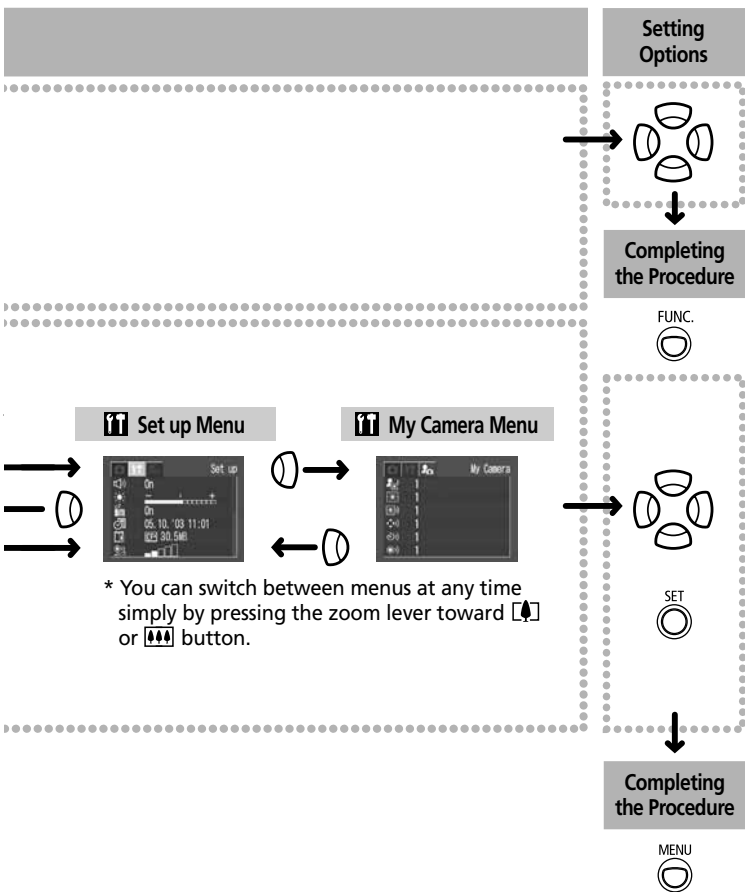

See *Selecting Images for Printing* (p. 111) for the procedures for the  (Print Order) item in the Play menu.



\* You can switch between menus at any time simply by pressing the zoom lever toward  or  button.

## Menu Settings and Factory Defaults





















This chart shows the options and default settings for each menu.

























### Items Set with the FUNC. Button

Menu Item	Available Settings	Reference Page
Exposure Compensation	-2 to ±0* to +2	p. 70
Long Shutter	Off*/ 1 to 15 seconds	p. 71
White Balance	Auto*/  Daylight /  Cloudy/  Tungsten Fluorescent /  Fluorescent H /  Custom	p. 73
ISO Speed	Auto / 50* / 100 / 200 / 400	p. 77
Color Effect	Effect Off*/  Vivid /  Neutral / Low Sharpening /  Sepia /  BW	p. 76
Compression (Still images)	Superfine /  Fine* /  Normal	p. 51
Resolution (Still images)	<b>L</b> 2272 x 1704*/ <b>M1</b> 1600 x 1200 / <b>M2</b> 1024 x 768 / <b>S</b> 640 x 480	p. 51
Resolution (Movie)	<b>320</b> 320 x 240*/ <b>160</b> 160 x 120	p. 51



### Items Set with the MENU Button

	Menu Item	Available Settings	Reference Page
Rec. Menu (Red)	AiAF	On*/ Off	p. 68
	Cont. Shooting	*/	p. 57
	Self-timer	*/	p. 58
	AF-assist Beam	On*/ Off	pp.36/128
	Digital Zoom	On / Off*	p. 56
	Image Review	On / 2* to 10 sec.	p. 50
	Long Shutter	On / Off*	p. 71

	Menu Item	Available Settings	Reference Page
Play Menu (Blue)	 Protect	Turns image protection On/Off.	p. 94
	 Rotate	Rotates the image in the display.	p. 87
	 Sound Memo	Adds a sound memo to the image in the display.	p. 88
	 Erase all	Erases all images on the CF card.	p. 96
	 Slide Show	Replays selected images in a slide show.	p. 90
	 Print Order	Sets the print settings.	p. 111
	 Transfer Order	Sets the transfer settings.	p. 119
Set up Menu (Yellow)	 Beep	On*/Off	p. 130
	 LCD Brightness	-7 to 0* to +7	p. 130
	 Auto Power Down	On*/Off	p. 27
	 Date / Time	Sets the date and time.	p. 23
	 Format	Formats (initializes) the CF card.	p. 97
	 Shutter Volume	Off / 1 / 2* / 3 / 4 / 5	p. 131
	 Playback Vol.	Off / 1 / 2* / 3 / 4 / 5	p. 131
	 Start-up Vol.	Off / 1 / 2* / 3 / 4 / 5	p. 132
	 Operation Vol.	Off / 1 / 2* / 3 / 4 / 5	p. 132
	 Selftimer Vol.	Off / 1 / 2* / 3 / 4 / 5	p. 132
	 File No. Reset	On / Off*	p. 79
	 Auto Rotate	On*/Off	p. 78
	 Language	English*/Deutsch / Français / Nederlands / Dansk / Suomi / Italiano / Norsk / Svenska / Español / Chinese / Japanese	p. 25
 Video System	NTSC*/PAL	p. 121	

Menu Item		Available Settings	Reference Page
My Camera Menu (Blue)	 Theme	 / <b>1</b> * /  / 	p. 45
	 Start-up Image	 / <b>1</b> * /  / 	p. 45
	 Start-up Sound	 / <b>1</b> * /  / 	p. 45
	 Operation Sound	 / <b>1</b> * /  / 	p. 45
	 Selftimer Sound	 / <b>1</b> * /  / 	p. 45
	 Shutter Sound	 / <b>1</b> * /  / 	p. 45

\* Default setting. Default video system setting varies between regions.

- Some menu items are not available in certain shooting modes.
- You can apply a desired image and sound to  and  in the My Camera menu. For details, see *Registering My Camera Settings* (p. 46) or the *Software Starter Guide*.
- With the exception of the [Date/Time], [Language] and [Video System] settings, all the other menu settings and changes made with the camera buttons can be reset to the default values in a single operation (p. 136).

# Customizing the Camera

## (My Camera Settings)

My Camera allows you to customize the start-up image and start-up, shutter, operation and self-timer sounds. Each menu item has three choices.

Example: Start-up Image



**1**

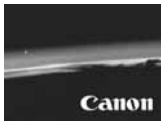

**2**



**3**

The **2** option features science fiction related images and sounds. The **3** option features animals.

## Changing My Camera Settings

**1**

Select an item in the My Camera menu.





**2**

SET MENU DISP. FUNC.





- See *Selecting Menus and Settings* (p. 38).

- Use the  or  buttons to select an option.

- The display will return to the Rec. or Play screen.



- If you select  (Theme) in Step 1, you can select a consistent theme for each of the My Camera Settings.
- If the Beep option in the **1** (Set up) menu is set to [On], the beep sounds even if each sound item is individually set to  [Off] in the My Camera menu (p. 135).

## Registering My Camera Settings

Images recorded onto the CF card and newly recorded sounds can be added as My Camera settings to the **12** and **13** menu items. You can also use the supplied software to upload your computer's images and sounds to the camera.

### Registering CF Card Images and Sounds

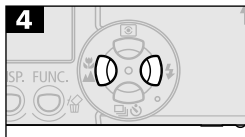

- See *Selecting Menus and Settings* (p. 38).

- Use the **10** or **11** buttons to select **12** or **13**.

- Use the **10** or **11** buttons to select an image or record a sound.





### Start-up Image

- Use the  $\odot$  or  $\ominus$  button to select the image you wish to register.



### Start-up, Operation, Self-timer, and Shutter Sounds

- Use the  $\odot$  or  $\ominus$  buttons to select  and press the **SET** button. Recording will start and automatically stop when the time is exceeded. After recording, use the  $\odot$  or  $\ominus$  buttons to select



- Use the  $\odot$  or  $\ominus$  buttons to select [OK].
- To cancel the change, select [Cancel].



- Sounds recorded with the movie and sound memo functions cannot be added as My Camera settings.
- The prior setting is erased when a new My Camera setting is added.

## File Format of My Camera Settings

My Camera settings should conform to the below file formats. However, CF card images shot with this camera can be registered as My Camera settings regardless of the below formats.

### Start-up Image

- Recording Format: JPEG (Baseline JPEG)
- Sampling Rate: 4:2:0 or 4:2:2
- Dimensions: 320 x 240 pixels
- File Size: 20 KB or less

### Start-up, Operation, Self-timer and Shutter Sounds

- Recording format: WAVE (monaural)
- Quantization Bits: 8 bit
- Sampling Frequency: 11.025 kHz or 8.000 kHz
- Recorded Length

	11.025 kHz	8.000 kHz
Start-up Sound	1.0 sec. or less	1.3 sec. or less
Operation Sound	0.3 sec. or less	0.4 sec. or less
Self-timer Sound	2.0 sec. or less	2.0 sec. or less
Shutter Sound	0.3 sec. or less	0.4 sec. or less

\* Any file formats other than those described above cannot be used with this camera.

An example of this function is to record "Say Cheese" as a self-timer sound so that the camera will replay this sound 2 seconds before the photo is taken. You could also record cheerful music to bring out the natural smiles of your subjects, or so they can strike a pose fitting the music. In these ways you can customize your camera by creating and adding new My Camera settings.







See the supplied *Software Starter Guide* for more information on creating and adding to the My Camera files.

# Shooting

## Selecting a Shooting Mode

The camera features the following shooting modes.

	Auto	Most settings are automatically selected by the camera.
	Manual	The exposure compensation, white balance and other settings can be manually selected.
	Stitch Assist	Images are shot in overlapping series to create single panoramic images.
	Movie	Shoots movie clips.

Some settings selected in each shooting mode are saved when the power is turned off (p. 161).

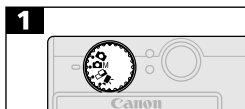

- Select a shooting mode with the shooting mode dial.

In the descriptions of the shooting functions that follow, the icons beside the titles indicate the applicable shooting modes. Before you proceed with Step 1 in each case, set the camera to one of the shooting modes indicated by the icons in the title (p. 2).

## Reviewing an Image Right after Shooting

Right after a shot is taken, the image appears in the LCD monitor for 2 seconds even if you release the shutter button regardless of whether the LCD monitor is on or off.

You can also review it with the following procedures.

- By keeping the shutter button pressed after a shot.
- By pressing the **SET** button while the image is displayed on the LCD monitor.

Press the shutter button halfway to stop displaying it so that you can shoot the next frame.



You can do the following while the image is displayed.



- Check the image brightness in the histogram (p. 33).
- Erase the image (p. 95).
- Magnify the image in the display (p. 81).

## Changing the Review Duration

The default review time is 2 seconds.

The review function can be set to [Off] or changed to any time in the range of 2 to 10 seconds in one-second increments.



- See *Selecting Menus and Settings* (p. 38).
- Use the  or  button to select [Off], or a time from [2 sec.] to [10 sec.].
- With the [Off] option, the image will not automatically display. However, if you keep the shutter button fully pressed after a shot, the image will display.
- In the [2 sec.] to [10 sec.] range, the image will continue to display for the specified time even if the shutter button is released. You can display the image for longer than the set duration by keeping the shutter button pressed all the way.



- The display will return to the Rec. screen.

## Changing Resolution / Compression Settings

You can change the resolution and compression (excluding movies) settings to suit the purpose of the image you are about to shoot.

Resolution		Purpose
<b>L</b> (Large)	2272 x 1704 pixels	Large  Small
<b>M1</b> (Medium 1)	1600 x 1200 pixels	
<b>M2</b> (Medium 2)	1024 x 768 pixels	
<b>S</b> (Small)	640 x 480 pixels	
		- Print A4 size* 210 x 297 mm (8.3 x 11.7 in.) or larger prints - Print Letter size* 216 x 279 mm (8.5 x 11 in.) or larger prints - Print postcard size 148 x 100 mm (6 x 4 in.) prints - Print L-size 119 x 89 mm (4.7 x 3.5 in.) prints - Print card size 86 x 54 mm (3.4 x 2.1 in.) prints - Send images as e-mail attachments - Shoot more images

\*Paper sizes vary according to region.

Compression		Purpose
 Superfine	High Quality  Normal	- Shoot higher quality images
 Fine		- Shoot normal quality images
 Normal		- Shoot more images

Movies can be shot with the following resolution.

Resolution	
<b>320</b>	320 x 240 pixels
<b>160</b>	160 x 120 pixels

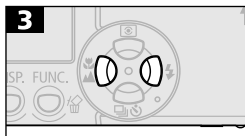
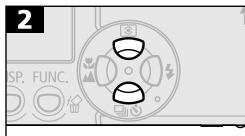

- Use the or button to select **L**\* or **M1**/**M2**.\*
- \*The current setting is displayed.

- Use the or buttons to select a compression or resolution option.



#### Compression (Excluding Movies)

Select , or .



#### Resolution (Still Images)

Select **L**, **M1**, **M2** or **S**.



#### Resolution (Movies)

Select or .

- You can shoot right after selecting an option. The menu displays again after the shot, allowing you to change the settings easily.



- The display will return to the Rec. screen.



- See *Functions Available in Each Shooting Mode* (p. 160).
- See *Image File Sizes* (p. 151).
- See *CF Cards and Estimated Capacities* (p. 151).

## ⚡ Using the Flash



	Auto	The flash fires automatically as required by the light level.
	Red-Eye Reduction Auto	The red-eye reduction lamp fires with each shot, automatically adjusting the intensity to suit lighting levels.
	Flash On	The flash fires with every shot.
	Flash Off	The flash will not fire.
	Slow-Synchro	The flash timing is adjusted to slow shutter speeds. This reduces the chance that the background will be dark when shots are taken at night or in rooms with artificial lighting. The red-eye reduction lamp fires with each shot. Use of a tripod is recommended.

	●	●	–
	●	●	–
	–	●	▲
	●	●	▲
	–	●	▲

- Setting available
- ▲ Can be selected for the first image only.

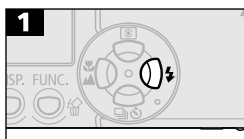

- Press the button to cycle through the flash settings.





- When you use flash photography at higher ISO speeds, the chances of white streaks appearing in the image increase the closer you approach to the subject.
- Since a slow shutter speed is selected in dark places when the flash is set to Off or Slow-Synchro, take care to avoid blurring the image.

#### - Shooting in Mode

Be careful to hold the camera still to avoid camera shake.



#### - Shooting in or Mode

Fix the camera to a tripod to shoot in these modes since the shutter speed will be slower than in the  mode. If an image is dark in  mode, reshooting it in  mode will make it brighter.





- The flash can be fired when the upper indicator lights a steady orange after pressing the shutter button halfway (The flash will not fire when it is set to Off).
- The flash may take up to approximately 10 seconds to charge. The recharging time will vary with such factors as the shooting conditions and battery charge. Shots cannot be taken while the flash is charging.
- The flash fires twice. The main flash follows a preparatory pre-flash. The exposure reading obtained from the subject with the pre-flash is used to set the optimal flash intensity for the main flash, which is used to capture the image.







### Red-Eye Reduction

- Light reflecting back from eyes can make them appear red when the flash is used in dark areas. Under these conditions, use the red-eye reduction mode. For this mode to be effective, the subject must be looking right at the red-eye reduction lamp. Try asking them to look directly at the lamp. Even better results can be obtained by shooting with the lens set to a wide angle, increasing the lighting in indoor settings or approaching closer to the subject.
- The shutter will not activate for approximately 1 second after the red-eye reduction lamp fires in order to improve the effect. If you want a more immediate shutter response, set the flash to ,  or .



## / Shooting Close-Ups/Infinity Shots

	Macro	Use this mode to record subjects in the range of 5 to 46 cm (2 in. to 1.5 ft.) from the lens tip when at wide-angle end and in the range of 30 to 46 cm (11.8 in. to 1.5 ft.) when at the telephoto end setting.
	Infinity	Use this mode to record landscapes and distant objects. It can also be used for compositions combining both near and distant objects.

				
	●	●	▲	●
	—	●	▲	●

● Setting available.

▲ Selectable for first image only.

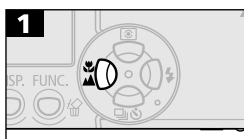

- Display  or .



- Use the LCD monitor to compose close-ups in macro mode since the parallax phenomenon may cause images composed with the optical viewfinder to be off-center (p. 34).
- The exposure may not be optimal when the flash is used in macro mode in the range of 5 to 30 cm (1.5 to 11.8 in.).



### Image Area in Macro Mode

	Distance from Lens to Subject	Image Area
Telephoto End	30 cm (11.8 in.)	107 x 80 mm (4.2 x 3.1 in.)
Wide-Angle End	5 cm (1.5 in.)	58 x 43 mm (2.3 x 1.7 in.)

## Using the Digital Zoom



When the LCD monitor is on, images can be zoomed to approximately 4.3, 5.3, 6.7, 8.2 and 11 times with the combined optical and digital zoom functions.



- Turn the LCD monitor on.

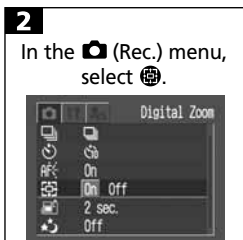

In the (Rec.) menu, select .

- See *Selecting Menus and Settings* (p. 38).

- Use the or button to select [On].



- The display will return to the Rec. screen.

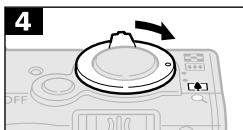

- Press the zoom lever toward until the lens reaches the maximum optical telephoto setting and stops. Press it again to activate the digital zoom and to advance through the settings.
- Press the button to zoom back out.



The combined optical and digital zoom factor displays.



The digital zoom cannot be used when the LCD monitor is turned off.







Images become coarser the more they are digitally zoomed.

## Continuous Shooting



In this mode, the camera shoots continuously while the shutter button is held down. Recording ceases when the shutter button is released.

	Standard Continuous Shooting	Use this mode to view images as you shoot continuously. The shutter interval is longer in this mode than in  mode.
	High-Speed Continuous Shooting	Use this mode to shoot continuously with a short shutter interval. You cannot check images while shooting continuously.

- 1** In the  (Rec.) menu, select .







- 2** SET MENU DISP. FUNC.

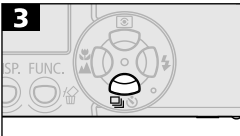



- 3**



- See *Selecting Menus and Settings* (p. 38).

- Use the  or  button to select  or .

- The display will return to the Rec. screen.

-  or  will display on the LCD monitor depending upon the option selected in the Rec. menu.

- The continuous shooting function shoots at the following rates.\*

 Approximately 1.5 frames/sec.

 Approximately 2.5 frames/sec.

- \* Large/Fine, LCD monitor off mode. (These figures reflect Canon's testing standard. The actual figures will vary according to the shooting conditions and settings.)



- The interval between shots may lengthen slightly when the camera's built-in memory fills.
- If the flash is firing, the interval between shots will lengthen to accommodate the flash's charging requirements.

## Using the Self-timer

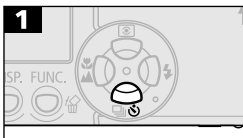

- Display or .
- When the shutter button is pressed, the self-timer will activate and the self-timer lamp will blink.

## Changing the Self-timer Countdown Time



- See *Selecting Menus and Settings* (p. 38).
- Use the or button to select [] (10 sec.) or [] (2 sec.)
- When [] (10 sec.) is selected, the self-timer sound and the blinking gets faster 2 second before the shutter activates.
- When [] (2 sec.) is selected, the self-timer sounds at the same time as the shutter button is pressed. The shutter activates in 2 seconds.
- The display will return to the Rec. screen.



The self-timer sound can be changed with the Selftimer Sound item in the (My Camera) menu (p. 134).

## Shooting in Stitch Assist Mode



Stitch Assist mode can be used to shoot overlapping images that can later be merged (stitched) to create one panoramic image on a computer.



The overlapping seams of several adjacent images can be joined into a single panoramic image.



To merge the images on a computer, use PhotoStitch, one of the supplied programs.

## Framing a Subject

The PhotoStitch program detects the overlapping portions of adjoining images and merges them. When shooting, try to include a distinctive item (landmark) in the overlapping portions.





- Compose each frame so that it overlaps 30 - 50% of the adjoining image. Try to keep the vertical misalignment to less than 10% of the image height.
- Do not include moving items in the overlap.



- Do not try to stitch images that include both distant and close items. These items may appear warped or doubled up in the merged image.
- Make the brightness in each image consistent. The final image will appear unnatural if the contrast in brightness is too great.
- To shoot landscapes, swivel (pan) the camera around its own vertical axis.
- To shoot close-ups, slide the camera over the subject, keeping it parallel to the subject as you move it.

## Shooting

Images can be shot in two sequences in Stitch Assist mode.

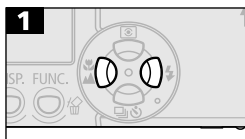
	Left to right horizontally
	Right to left horizontally



- The LCD monitor turns on when the shooting mode dial is set to .
- Use the  or  buttons to select the sequence direction.



 Left to right horizontally

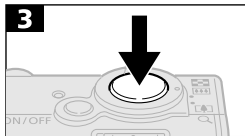

- Shoot the first frame in the sequence.
- The exposure and white balance are set and locked with the first image.

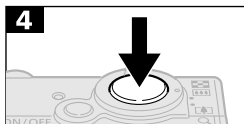

Second Image

- Compose the second image so that it overlaps a portion of the first and shoot.



- Use the  $\odot$  or  $\ominus$  button to check or retake the recorded images.
- Minor discrepancies in the overlapping portions can be corrected when the images are stitched together.

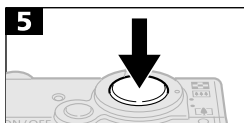

Third Image

- Repeat the procedure for additional images. A sequence may contain up to 26 images.



- Press the **SET** button to close Stitch Assist mode.



- A custom white balance setting cannot be set in  $\square$  mode. To use a custom white balance setting, first set it in another shooting mode (p. 74).
- The settings for the first image are used to take subsequent images in the sequence.
- It is not possible to display images on the TV when shooting in Stitch Assist mode.



See the *Functions Available in Each Shooting Mode* (p. 160).

## ▶ Shooting a Movie



Select the **320** (320 x 240, default) resolution or **160** (160 x 120) resolution (p. 51).

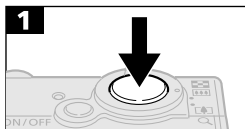

- Press the shutter button fully to start recording images and sounds.
- During shooting the recording time (in seconds) and a red circle appear on the LCD monitor.

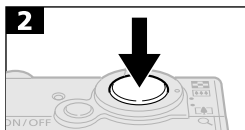

- Press the shutter button again to stop recording.
- The maximum length of a movie clip (at 15 frames/sec.) is 3 minutes. (According to Canon's standardized tests). These times may vary with the subject and shooting conditions. Recording will automatically stop when the maximum is reached or when the CF card runs out of free capacity.





- 
- You are recommended to use a CF card that has been formatted in your camera to shoot movies (p. 97). The card supplied with the camera may be used without further formatting.
  - Be careful not to touch the microphone while recording.
  - The AE, AF, white balance and zoom settings remained fixed for subsequent frames at the values selected for the first frame.
  - After a clip is shot, the upper indicator will blink green while the clip is being written to the CF card. You cannot shoot again until the blinking stops.



- 
- See the *Functions Available in Each Shooting Mode* (p. 160).
  - Sound is recorded monaurally.
  - The shutter sound will not sound when you fully press the shutter button to record a movie clip.
  - QuickTime 3.0 or later is required to replay movie files (AVI/Motion JPEG) on a computer. QuickTime (for Windows) is included on the Canon Digital Camera Solution Disk. On the Macintosh platform, this program is generally bundled with Mac OS 8.5 or later operating systems.
-

## Locking the Focus (AF Lock)



It may be difficult to focus on the following types of subjects. Use the focus lock in these situations.

- Subjects with extremely low contrast to the surroundings
- Subjects with extremely bright objects at the center of the composition
- Subjects that are moving quickly
- Subjects through glass :

Try to shoot as close to the glass as possible to reduce the chances of light reflecting back off the glass.

## Shooting with the Focus Lock

### Method 1

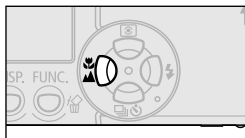
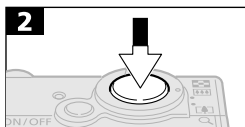

- 1** Aim the camera so that an object at the same focal distance as the main subject is centered in the AF frame in the viewfinder or LCD monitor.
- 2** Press the shutter button halfway and wait until two beeps sound.
- 3** Re-aim the camera to compose the shot as desired and press the shutter button all the way.

### Method 2

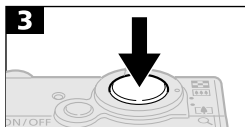

- Turn the LCD monitor on.
- Aim the camera so that an object at the same focal distance as the main subject is centered in the AF frame.
- Press and hold the shutter button halfway until two beeps sound. Without releasing your finger, press the / button.
- The **AFL** icon will display and the lower indicator will light yellow.



- Re-aim the camera to compose the shot as desired and press the shutter button all the way.
- Release the focus lock by pressing the  /  button.



- Method 2 is convenient because you can let go of the shutter button to recompose the image. Moreover, the focus remains locked after the picture is taken, allowing you to capture a second image with the same focus.
- In Method 2, pressing the zoom lever, **MENU** button or **DISP.** button, or changing the shooting mode also releases the focus lock.

## Locking the Exposure Setting (AE Lock)



You can set the exposure and focus separately. This is effective when the contrast is too strong between the subject and background or when a subject is backlit.



You must set the flash to . The AE lock cannot be set if the flash fires.



1

- Turn on the LCD monitor.
- Focus the camera on the subject on which you wish to lock the exposure setting.

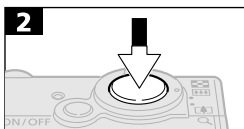

2

- Press the shutter button halfway and wait until two beeps sound.

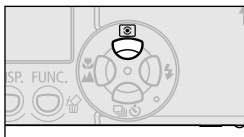

3

- Without releasing your finger, press the button.
- The **AEL** icon will display.

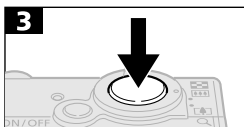

- Re-aim the camera to compose the shot.
- To release the AE lock, press the button.



The AE lock may also release if you press any button other than the button.

## Locking the Flash Exposure Setting (FE Lock)

You can lock the flash exposure so that the exposure settings are correctly set for a particular portion of your subject.



- Turn on the LCD monitor.
- Set the flash to  and focus on the part of the subject on which you wish to lock the flash exposure setting.

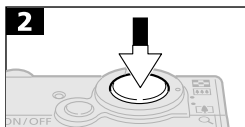

- Press the shutter button halfway and wait until two beeps sound.

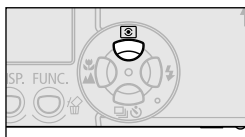

- Without releasing your finger, press the  button.
- The flash will fire a pre-flash and lock the flash exposure to the required intensity to illuminate the subject.
- The **FEL** icon will display.

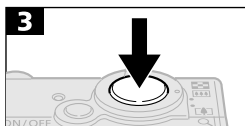

- Re-aim the camera to compose the shot and press the shutter button all the way.
- To release the FE lock, press the  button.



The FE lock may also release if you press any button other than the  button.

## Switching between Autofocus Modes



Although the autofocus function is preset to the AiAF setting (nine AF frames), you can set it to the center AF frame. When the center AF frame is selected, the AF frame will appear in the LCD monitor if it is turned on (p. 29). The AF frame does not appear when AiAF is selected.

No frame	On	The camera detects the subject and highlights the AF frames, from 9 available points, that it will use to determine the focus.
<input type="checkbox"/>	Off	The camera focuses using the center AF frame. This is convenient for focusing on a specific part of a subject with greater certainty.

The  symbol represents the AF frames as they appear in the LCD monitor.



- See *Selecting Menus and Settings* (p. 38).





- Use the or button to select [On] or [Off].
- A shot can be taken immediately after.
- The display will return to the Rec. screen.



The center AF frame mode is used when the digital zoom is activated.

## Switching between Light Metering Modes

You can switch between metering modes to shoot.

	<b>Evaluative Light Metering</b>	Appropriate for standard shooting conditions, including backlit scenes. The camera divides images into several zones for light metering. It evaluates complex lighting conditions, such as the position of the subject, the brightness, the direct light, and the backlighting, and adjusts the settings to the correct exposure for the main subject.
	<b>Center-Weighted Averaging</b>	Averages the light metered from the entire frame, but gives greater weight to the subject matter at the center.
	<b>Spot AE Point</b>	Meters the area within the spot AE point at the center of the LCD monitor. Use this mode when the subject is backlit or surrounded by strong light.

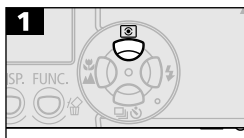

- Display ,  or .

## Adjusting the Exposure Compensation



Adjust the exposure compensation setting to avoid making the subject too dark when it is backlit or shot against a bright background or to avoid making lights appear too bright in night shots.

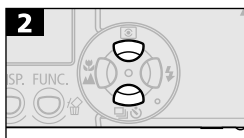

- Use the or button to select **±0**\*.
- \* The current setting is displayed.

- Use the or buttons to adjust the exposure compensation.
- The settings can be adjusted in 1/3 steps in the range -2 to +2.
- You can confirm the effect of the setting in the LCD monitor when it is on.
- You can shoot right after selecting a value. The menu displays again after the shot, allowing you to change the settings easily.
- Reset the exposure compensation by returning the setting to "0".



## Shooting in Long Shutter Mode



You can set the shutter speed to a slow setting to make dark subjects appear brighter.



- See *Selecting Menus and Settings* (p. 38).

- Use the or button to select [On].



- The display will return to the Rec. screen.



- The exposure compensation menu will display in the LCD monitor.

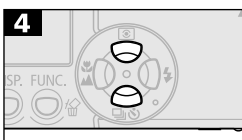

- Use the or button to select  $\pm 0^*$ .
- \* The current setting is displayed.



- The long shutter submenu will display.

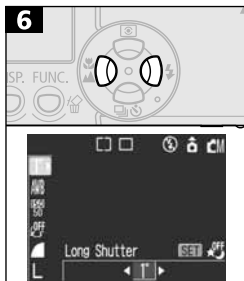

- Use the  $\odot$  or  $\ominus$  button to select a shutter speed. The higher the value, the brighter the image and the lower the value, the darker the image.
- You can shoot right after selecting a value. The menu displays again after the shot, allowing you to change the settings easily.
- To cancel the long shutter mode, press the **SET** button while the long shutter menu is displayed.



The nature of CCD image sensors is such that noise in the recorded image increases at long shutter speeds. This camera, however, applies special processing to images shot at shutter speeds slower than 1.3 seconds to eliminate the noise, thereby producing high-quality images. Nevertheless, a certain amount of processing time may be required before the next image can be shot.



- Use the LCD monitor to confirm that the image was recorded at the desired brightness.
- Use of the flash may result in an over-exposed image. If that occurs, shoot with the flash set to  $\text{⊗}$ .
- The following are unavailable:
  - Exposure Compensation
  - Light Metering
  - AE Lock
  - FE Lock
  - ISO speed (AUTO)
  - Flash (Auto), (Red-Eye Reduction)
- **Available Shutter Speeds**  
The following shutter speeds (in seconds) are available.  
1, 1.3, 1.6, 2, 2.5, 3.2, 4, 5, 6, 8, 10, 13, 15

## Setting the White Balance



When the white balance mode is set to match the light source, the camera reproduces colors more accurately.

	Auto	The camera sets the white balance automatically according to shooting conditions.
	Daylight	For recording outdoors on a bright day.
	Cloudy	For recording under overcast, shady or twilight skies.
	Tungsten	For recording under tungsten and bulb-type 3-wavelength fluorescent lighting.
	Fluorescent	For recording under warm-white, cool-white or warm-white (3-wavelength) fluorescent lighting.
	Fluorescent H	For recording under daylight fluorescent, or daylight fluorescent-type (3-wavelength) fluorescent lighting.
	Custom	For setting a custom value with a white sheet of paper, etc., to obtain the optimal white balance for the conditions.

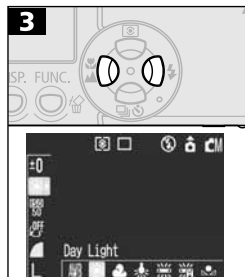
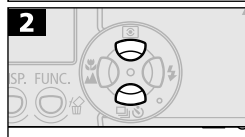



- Use the or buttons to select **AWB**\*.

\* The current setting is displayed.

- Use the or buttons to select an option. (See p. 74 for the option.)
- You can confirm the effect of the setting in the LCD monitor when it is on.
- You can shoot right after selecting an option. The menu displays again after the shot, allowing you to change the settings easily.





This setting cannot be adjusted when the  (Sepia) or  (B/W) photo effects are selected.

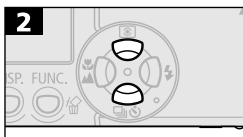

## Setting a Custom White Balance

You can set a custom white balance to obtain the optimal setting for the shooting conditions by having the camera evaluate an object, such as a piece of white paper or cloth, or a photo-quality gray card that you wish to establish as the standard white color.



- Use the  or  buttons to select \*.
- \* The current setting is displayed.







- Use the  or  buttons to select .





- Aim the camera so that a piece of white paper, a cloth or a gray card completely fills the frame at the center of the LCD monitor or the entire optical viewfinder, then press the **SET** button. The camera reads the white balance data when you press the **SET** button.
- You can shoot right after setting the white balance. The menu displays again after the shot, allowing you to change the settings easily.



- You are recommended to set the shooting mode to  and the exposure compensation setting to zero ( $\pm 0$ ) before setting a custom white balance. The correct white balance may not be obtained when the exposure setting is incorrect (image appears completely black or white).
- It is also advisable to use the LCD monitor to compose the shot and to zoom in to the telephoto end setting.
- Since the white balance data cannot be read in  mode, preset the white balance in another shooting mode first before selecting the  mode.
- Set the flash on or off when setting a custom white balance. The white balance may not be accurate if the setting conditions and shooting conditions are not the same. If the flash fires when setting a custom white balance with the flash set to  or , ensure that you also use the flash when you go to shoot.

## Changing the Photo Effect



You can shoot with different photo effects.

	Photo Effect Off	Records with no effect.
	Vivid	Emphasizes the contrast and color saturation to record bold colors.
	Neutral	Tones down the contrast and color saturation to record neutral hues.
	Low Sharpening	Records subjects with softened outlines.
	Sepia	Records in sepia tones.
	B/W	Records in black and white.

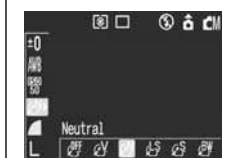
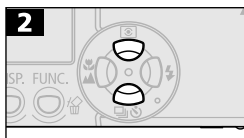

- Use the or button to select \*.
- \* The current setting is displayed.

- Use the or buttons to select an effect.
- You can confirm the effect in the LCD monitor when it is on.
- You can shoot right after selecting an option. The menu displays again after the shot, allowing you to change the settings easily.

## Adjusting the ISO Speed



Raise the ISO speed when you wish to reduce camera shake or turn the flash off when shooting in a dark area, or use a fast shutter speed.

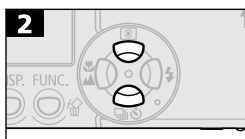

- Use the or button to select \*.
- \* The current setting is displayed.



- Use the or buttons to select a speed.
- You can shoot right after selecting an option. The menu displays again after the shot, allowing you to change the settings easily.



- Higher ISO speeds increase image noise. To take clean images, use as low an ISO speed as possible.
- Although the AUTO setting selects the optimal speed, it will automatically raise the speed when the shooting condition limits are reached. It will also raise the speed when the light from the flash is insufficient to illuminate the subject matter.

## Setting the Auto Rotate Function



Your camera is equipped with an Intelligent Orientation sensor that detects the orientation of an image shot with the camera on end and automatically rotates it to the correct viewing orientation in the display. You can set this function on/off.

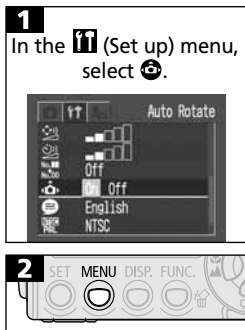

- See *Selecting Menus and Settings* (p. 38).
- Use the **Q** or **Q** button to select [On] or [Off].
- The display will return to the Rec. screen.
- When the Auto Rotate function is set to [On] and the LCD monitor is set to the detailed display mode, the **Auto Rotate** icon (normal), **Auto Rotate** icon (right end is down) or **Auto Rotate** icon (left end is down) will appear in the upper right of the display.



- When the camera is held on end to shoot, the Intelligent Orientation sensor judges the upper end to be "up" and the lower end to be "down." It then regulates the optimal white balance, exposure and focus for vertical photography. This function operates regardless of the On/Off status of the Auto Rotate function.
- When changing the camera's orientation between the horizontal and vertical positions, you may hear noise coming from the orientation detection mechanism. This is not a malfunction.



- This function may not operate correctly when the camera is pointed straight up or down. Check that the arrow is pointing in the right direction and if it is not, then set the Auto Rotate function to [Off].
- Even if the Auto Rotate function is set to [On], the orientation of images downloaded to a computer will depend upon the software used to download the images.



## Resetting the File Number



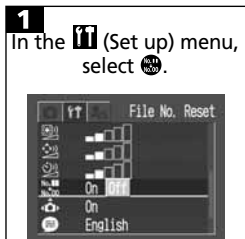

You can select the way file numbers are assigned.

On	The file number is reset to the start (100-0001) each time a new CF card is inserted. New images recorded on CF cards with existing files are assigned the next available number.
Off	The file number of the last image to be shot is memorized so that images recorded to a new CF card start from the next number.



- See *Selecting Menus and Settings* (p. 38).



- Use the  or  button to select [On] or [Off].

- The display will return to the Rec. screen.





- Setting the File No. Reset to [Off] is useful for avoiding file name duplication when images are downloaded to a computer.

### • About File and Folder Numbers

Images are assigned file numbers from 0001 to 9900, and folders are assigned folder numbers from 100 to 998 (Folder numbers cannot contain 99 in the last two digits).

### • Folder File Capacity

Each folder usually contains up to 100 images. However, since images shot in  and  are always saved into the same folder, a folder may contain more than 100 images. The number of images may also exceed 100 if a folder contains images copied from a computer or images shot with other cameras. Please note, however, that the images in folders containing 2001 or more images cannot be replayed in this camera.



# Replaying

## Displaying Images Individually

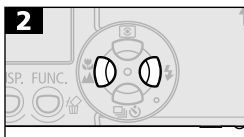

- Turn the mode switch to the  position.
- The last recorded image will appear in the display (single image replay).



- Use the  button to move to the previous image and the  button to move to the next. Holding the button down advances the images more rapidly, but the images will not appear as clearly.

## Q Magnifying Images

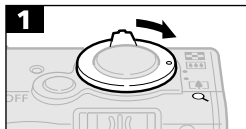

- Images can be magnified up to approximately 10 times.



Approximate Location of the Magnified Area

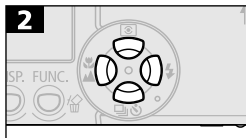

- Use the / / buttons to move around the image.
- Hold the **SET** button down and press the zoom lever toward to cycle through each setting, from approximately 2.5 times, to approximately 5 and 10 times.
- Hold the **SET** button down and press the zoom lever toward to cycle back through the levels of magnification from approximately 5 times, to 2.5 times and the standard view.



Movie frames and index replayed images cannot be magnified.

## Viewing Images in Sets of Nine (Index Replay)

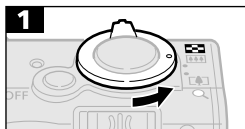

- Up to nine images can be viewed at once in index replay.



Selected Image

Movie

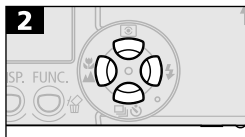

- Use the / / / buttons to change the image selection.
- Press the zoom lever toward **Q** to display the selected image in single image replay.

## Switching between Sets of Nine Images

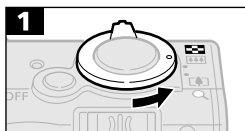

- Successive sets of nine images can be shown in the display.

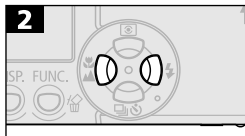

- Use the button to move to the previous set and the button to move to the next.
- Hold the **SET** button down and press the or button to jump to the first or last set.
- Press the zoom lever toward **Q** to return to standard index replay.

## Viewing Movies



Movie clips can be replayed with the following procedures.



Movies cannot be played in the index replay mode.

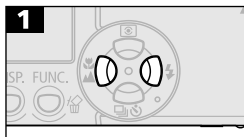

- Use the or button to select a movie.
- Images with a **SET** are movies.

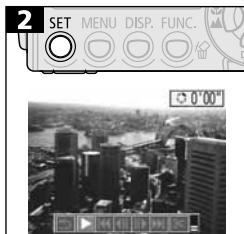

- The movie control panel will display.
- Use the or button to select (Play).



- The movie images and sound will play.
- Use the or buttons to adjust the sound volume.
- When a movie is finished, it stops and displays its last frame.

## Pausing and Resuming Play



- Press the **SET** button to pause the movie. Press it again to resume.

## Fast Forwarding/Rewinding

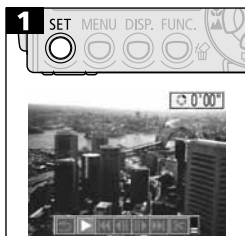

- Use the  or  button to select one of the following.

 Return to Single Image View

 Play

 First Frame

 Previous Frame

[Rewinds if **SET** button is held down]

 Next Frame

[Fast Forwards if **SET** button is held down]

 Last Frame

 Switch to Movie Editing Mode (p. 85)



Use the television's controls to adjust the volume when playing a movie on a TV set (p. 121).



- You may experience frame dropping and audio breakup when replaying a movie on a computer with insufficient system resources.
- Movies shot with other cameras may not replay on this camera. See the *List of Messages* (p. 137).

## Editing Movies



Selecting (Edit) in the movie control panel enables you to cut unwanted portions at the start or end of a movie clip.



Protected movies and movies less than 1 second in duration cannot be edited.

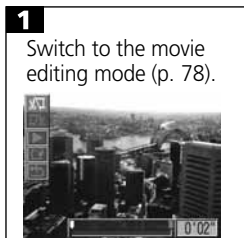

- Use the or button to select (Cut Beginning) or (Cut End) and the or button to set the portion to which the cut is applied.
- When (Cut Beginning) is selected, the left hand cursor moves and when (Cut End) is selected, the right hand cursor moves.

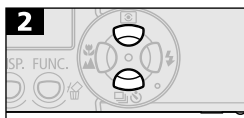

- Use the or button to select (Play).



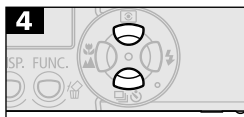

- A preview of the temporarily edited movie clip plays. To stop it, press the **SET** button again.



- Use the or button to select (Save) to keep the edits (p. 86). If you use the or button to select (Close Movie Editing/Return to Movie Control Panel), the edits are not saved and the editing mode is canceled.



- Use the  or  button to select [New File] or [Overwrite].
  - [New File] saves the edited movie under a new file name. The pre-edit data is left unchanged.
  - [Overwrite] saves the edited movie with its original file name. The pre-edit data is lost.
- When the CF card lacks sufficient space to create a new file, only [Overwrite] can be selected. A small ▲ symbol will appear in the time display on the movie in that case.



- The minimum duration of an edited movie is 1 second.
- It may take approximately 3 minutes to save an edited movie. If the battery pack runs out of charge partway through, edited movie clips cannot be saved. When editing movies, use a fully charged battery pack or the separately sold AC Adapter Kit ACK500 (P. 141).



## Rotating Images in the Display



Images can be rotated clockwise 90° or 270° in the display.



0°(Original)



90°



270°

**1**

In the (Play) menu, select .

**2**



**3**



- See *Selecting Menus and Settings* (p. 38).
- Use the or button to select the image to be rotated.
- Cycle through the 90°/270°/0° orientations with each press of the **SET** button.
- Press the **MENU** button repeatedly until the replay screen reappears to finish the procedure.



- Movies cannot be rotated.
- When images are downloaded to a computer, the orientation of images rotated by the camera will depend upon the software used to download the images.



Images taken vertically with the Auto Image Rotate (p. 78) set to [On] will automatically be rotated to the vertical position when viewed on the camera's LCD monitor.

## Attaching Sound Memos to Images

In replay mode (including single replay, index replay, and magnifying replay), you can attach sound memos (up to 60 seconds) to an image. The sound data is saved in WAVE format.

1

In the  (Play) menu, select .



- See *Selecting Menus and Settings* (p. 38).

2



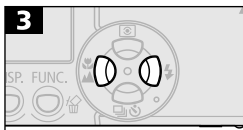



3

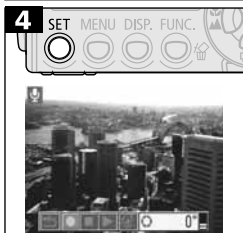

- Use the  or  button to select an image.

4



- The sound memo control panel will display.
- Use the  or  buttons to select .

5







- The recording starts and the elapsed time is displayed. Speak towards the microphone of the camera.
- Press the **SET** button again to stop recording. To resume recording, press the **SET** button again.
- Up to 60 seconds of recordings may be added to any one image.

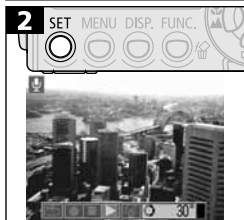

## • Playing/Erasing Sound Memos

- 1** Display an image with a sound memo attached (p. 94).





- Images with sound memos attached have a  symbol displayed on them in the LCD monitor.
- The sound memo control panel will display.
- Use the  or  buttons to select  (Play) or  (Erase).

### (Play)

- The sound memo will play. Playback will stop when you press the **SET** button. Press the **SET** button again to resume playback.
- Use the  or  buttons to adjust the sound volume.

### (Erase)

A confirmation menu will display. Use the  or  buttons to select [Erase] and press the **SET** button.

## • Exiting the Sound Memos

- Press the **MENU** button.



- You cannot attach sound memos to movies.
- The “Memory card full” message will display when the CF card is full and you will be unable to record sound memos to that card.
- If an incompatible sound memo is attached to an image, you will be unable to record or play sound memos for that image, and the “Incompatible WAVE format” message will display. You can erase incompatible sound data using the camera.
- Sound memos for protected images cannot be erased.



The volume can be adjusted in the  (Set up) menu (p. 131).

## Automated Playback (Slide Shows)



### Starting a Slide Show

A selection of images or all the images on a CF card can be displayed one-by-one in an automated slide show.

Slide show image settings are based on DPOF standards (p. 111).

All Images	Plays all images on the CF card in order.
Slide Show 1-3	Plays the images selected for each slide show in order (p. 91).

**1**

In the (Play) menu, select .

- See *Selecting Menus and Settings* (p. 38).

**2**

- The Slide Show menu will display.
- Use the or button to select [Program] and the or button to select [All Images], [Show 1], [Show 2] or [Show 3].
- Use the or button to select [Start].

**3**

- The slide show will start and automatically stop at the end of the show.

**4**

- Press the **MENU** button repeatedly until the replay screen reappears to finish the procedure.



- Movies play for their entire recorded length regardless of the time set in the slide show settings.
- The power-saving function does not activate during a slide show (p. 27).



## Pausing/Resuming a Slide Show

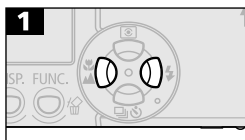

- Press the **SET** button to pause the slide show. Press the **SET** button again to restart it.

## Fast Forwarding/Rewinding a Slide Show



- Use the  or  button to display the previous or next image. Hold down the button to advance through the images more rapidly.

## Stopping a Slide Show









- Press the **MENU** button to stop the slide show and redisplay the Slide Show menu.

## Selecting Images for Slide Shows

You can mark images for inclusion in slide shows 1-3. Up to 998 images may be marked per slide show. Images display in the order of their selection.



- Use the  button to select [Program] and the  or  button to select [Show 1], [Show 2] or [Show 3].
- Use the  button and the  or  button to choose [Select].

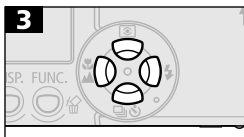

- A white checkmark will appear beside a show already containing images.

- Use the or button to move between images and the or button to select or deselect them. Selected images display a number corresponding to their selection order and a white checkmark .



- You can press the zoom lever toward to switch to the index mode (3 images) and use the same procedures to select images.





- While in index replay, you can clear all of the images by pressing the **SET** button, using the or button to select [Clear all] and pressing the **SET** button again.



- Press the **MENU** button repeatedly until the replay screen reappears to finish the procedure.

## Adjusting the Play Time and Repeat Settings



You can change the play time for all the images in a show and have the show repeat continuously.

 Play Time	Sets the duration that each image displays. Choose between 3-10 seconds, 15 seconds, 30 seconds and Manual.
 Repeat	Sets whether the slide show stops when all the slides have been displayed or continues until stopped.

**1**

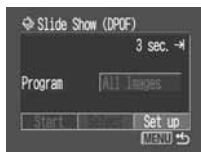
Display the Slide Show menu (p. 82).









- Use the  or  button to select [Set up].

**2**

SET MENU DISP. FUNC.



- Use the  or  button to select  or  and the  or  button to select an option.

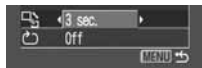

-  (Play Time)  
Select a play time.



-  (Repeat)  
Select [On] or [Off].

**3**

SET MENU DISP. FUNC.



- Press the **MENU** button repeatedly until the replay screen reappears to finish the procedure.



- The display interval may vary slightly from the set time for some images when played.
- Slide shows are easy to arrange on a computer with the supplied software. See the *Software Starter Guide*.

## Protecting Images



You can protect important images from accidental erasure.

**1**

In the (Play) menu, select .

**2**



**3**



- See *Selecting Menus and Settings* (p. 38).

- Use the or button to select an image to protect.
- Press the **SET** button to protect the image. Press the **SET** button again to remove the protection.
- You can make the selection of images easier by toggling between single image replay and index replay by pressing the zoom lever toward / .



Protection Icon

**4**



- Press the **MENU** button repeatedly until the replay screen reappears to finish the procedure.



Please note that formatting (initializing) a CF card erases all data, including protected images.



# Erasing



## Erasing Single Images



- Please note that erased images cannot be recovered. Exercise adequate caution before erasing a file.
- Protected images cannot be erased with this function.

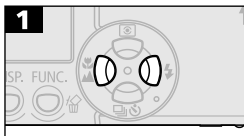

- Use the  $\odot$  or  $\text{O}$  button to select an image for deletion.



- Use the  $\odot$  or  $\text{O}$  button to select [Erase].
- To exit instead of erasing, select [Cancel].



## Erasing All Images



- Please note that erased images cannot be recovered. Exercise adequate caution before erasing a file.
- Protected images cannot be erased with this function.

**1**

In the (Play) menu, select .

- See *Selecting Menus and Settings* (p. 38).

**2**

- Use the or button to select [OK].
- To exit instead of erasing, select [Cancel].

**3**

## Formatting CF Cards



New CF cards must be formatted with the following procedures before use.



Please note that formatting (initializing) a CF card erases all data, including protected images and other file types.



- See *Selecting Menus and Settings* (p. 38).

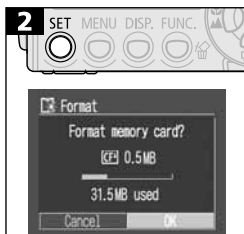

- Use the **[D]** or **[O]** button to select [OK].
- To exit instead of formatting, select [Cancel].



- When the camera is malfunctioning, a corrupted CF card might be the cause. Reformatting the CF card may solve the problem.
- When a non-Canon brand CF card is malfunctioning, reformatting it may solve the problem.
- CF cards formatted in other cameras, computers, or peripheral devices may not operate correctly in this camera. When that happens, reformat the CF card with this camera. If formatting in the camera doesn't work properly, turn the camera off and re-insert the CF card. Then turn the camera back on and format again.

# Printing

## About Printing

This camera supports direct printing. By connecting the camera to an optional direct print compatible printer (CP series, sold separately)\*<sup>1</sup> or Bubble Jet printer (sold separately) that supports the camera's direct print function, you can send the images from the CF card directly to the printer using the camera buttons. In addition, you can have prints made to specification by a photo developing service by sending your CF card with the DPOF\*<sup>2</sup> print settings set in advance on your camera. Please refer to the *System Map* supplied with your camera for direct print function compatible printer information.

\*<sup>1</sup> The direct print  icon appears on direct print compatible CP series printers.

\*<sup>2</sup> (Digital Print Order Format)

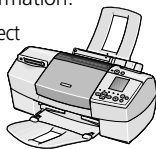

Bubble Jet Printer  
(Compatible with the  
direct print function)

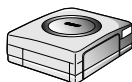

Card Photo Printer  
(Compatible with the  
direct print function)

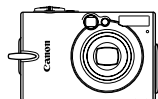

Digital Camera



CF Card



Photo Lab



Print

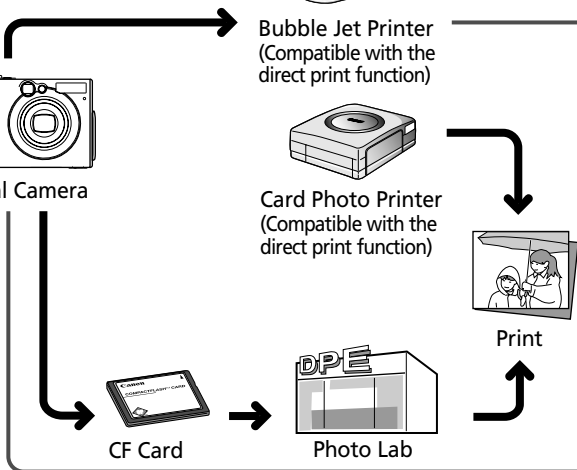

Please refer to the *System Map* supplied with your camera for direct print function compatible printer (CP series) information.

### Setting Print Settings for Direct Printing

- Setting the Number of Print Copies (p. 107)  
▼
- Setting the Print Style (p. 107)
  - Standard/Multiple  
(Direct Print Function Compatible Printer)
  - Paper: Card #1/Card #2/Card #3/LTR/A4  
(Direct Print Function Compatible BJ Printer)
  - Bordered/Borderless
  - Date: On/Off
- ▼
- Setting the Printing Area (Trimming) (p. 109)

### DPOF Print Settings

- Select the images you wish to print (p. 111).  
▼
- Set the number of print copies (p. 112).  
▼
- Set the print style (p. 114).
  - Standard/Index/Both.
  - Date: On/Off.
  - File Numbers: On/Off.

### DPOF Transfer Order

- Select the images to send by email (p. 119)  
Software that supports DPOF transfer order settings is required

## Print Menu Settings

Use the Print menu to set print related settings. The following diagrams illustrate how to use the Print menu.

### Direct Print Function

Set the Mode Switch to 

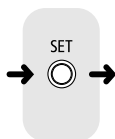

### DPOF Print Settings

Set the Mode Switch to 

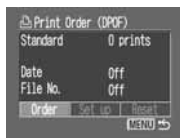
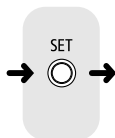
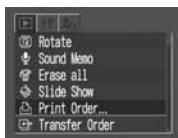



Turn the menu On/Off.



Selects items and settings.



Sets items and settings.

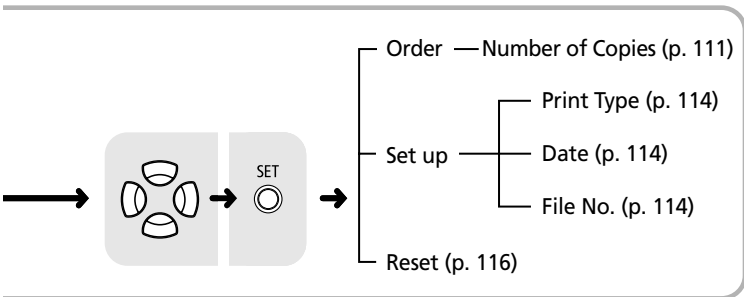
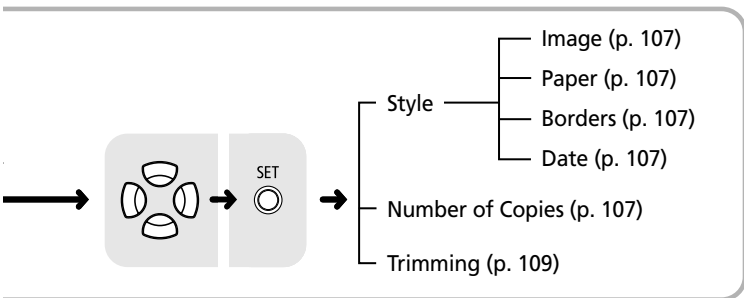

## Connecting a Printer

You can make clear prints swiftly and easily when you connect the camera to a direct print function compatible printer (CP series, sold separately) or a direct print function compatible Bubble Jet printer (sold separately). You can also print using DPOF print settings.



You are recommended to use the optional AC Adapter Kit ACK500 (sold separately) rather than the battery pack to power the camera when it is connected to a printer. If you do use a battery pack, ensure that it is fully charged and monitor the battery charge while printing.



- Please see the *System Map* supplied with your camera for information on direct print function compatible printers (CP series).
- Please see your printer's user guide for information about installing paper and ink cassettes/tanks.

### Connecting to a Direct Print Function Compatible Printer (CP Series)

Your printer should come equipped with two direct interface cables. To connect to this camera, please use the cable (DIF-100) that has the  symbol on its connector.

**1**

Shut the camera's power off (p. 26).

**2**

To a Power Outlet

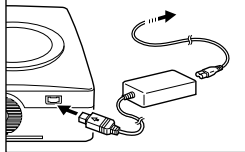

- Attach the power cable to the printer and insert its plug into a power outlet.
- You can also power the printer with a rechargeable battery if it is so equipped. Please see your printer's user guide.



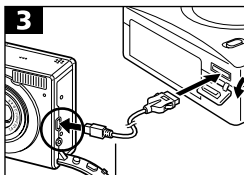



Direct Interface Cable (DIF-100)

- Attach the direct interface cable to the printer.
- Open the camera's terminal cover and insert the cable's connector into the camera's DIGITAL terminal. Orient the cable so that the connector's  symbol faces the camera's back panel.



- Press the printer's ON/OFF button to turn on its power. (If you are using Card Photo Printer CP-10, the printer's power will turn on in Step 2 when printer and power cable are connected.)
- Set the mode switch to the  position and turn on the camera's power.
-  will display when the printer is correctly connected.

This shows when a direct print function compatible printer is connected.



## Connecting to a Bubble Jet Printer





Please read the *Quick Start Guide* supplied with your Bubble Jet printer to see if it is compatible with the camera's direct print function, and for instructions regarding the connection cables and the printer's general operation.

**1**

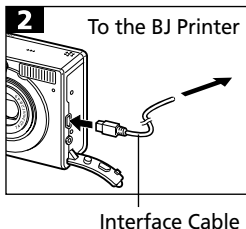

Shut the camera's power off (p. 26).



This shows when a BJ printer is connected.

- Turn the Bubble Jet printer's power on after you have connected the power cord to the Bubble Jet printer and inserted the other end in a power outlet.
- Attach the interface cable to the Bubble Jet printer.
- Open the camera's terminal cover and insert the cable's connector into the camera's DIGITAL terminal. Orient the cable so that the word Canon on the connector faces the camera's front panel.
- Set the mode switch to the  position and turn on the camera's power.
-  will display when the printer is correctly connected.



- On Bubble Jet printers with operation panels, images cannot be printed through the operation panel while the camera is connected.
- The following cannot be conducted while the printer is connected.
  - Playing movies
  - Setting the language with the **SET** and the **MENU** button combination.
- When the printer is disconnected, the  or  symbol will disappear from the LCD monitor and the camera will revert to the standard replay mode.
- Use the following procedures to detach the cable from the camera and printer.
  1. Detach the cable from the printer.
  2. Shut off the camera's power.
  3. Detach the cable from the camera.
- Ensure that you grip the connector's sides when you detach the cable from the camera's DIGITAL terminal.

## Printing

The following illustrations show examples from a direct print compatible printer (CP series). Options for the Style category will differ slightly for Bubble Jet printers.

Print images displayed in single image replay or index replay mode.

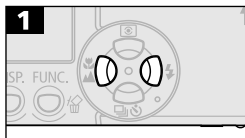

- Use the or button to select the images you wish to print.

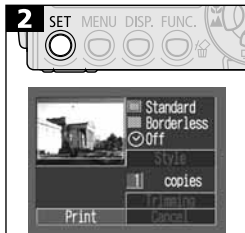

- Specify the number of print copies, print style and print area as required.
  - Setting the Number of Print Copies (p. 107)
  - Setting the Print Style (p. 107)
  - Setting the Printing Area (Trimming) (p. 109)
- Use the , , , or buttons to select [Print].
- To quit the procedure instead, select [Cancel].

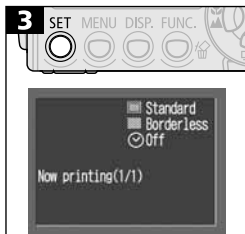

- Press the **SET** button to start printing.
- The replay screen will reappear when printing is successfully concluded.



**Movies cannot be printed.**



- **Canceling Printing**

Press the **SET** button to stop printing. A confirmation message will display. Use the **⏪** or **⏩** button to select [OK] and press the **SET** button.

- **Direct Print Function Compatible Printers (CP Series)**

A print in progress cannot be stopped. The printer will stop after the current print is complete and the camera will display its replay screen at that point.

- **Bubble Jet Printers**

The printer will stop printing the current image and eject the paper.

- **Printing Errors**

An error message will display if an error occurs while printing (p. 137, 138). Use the **⏪** or **⏩** button to select [Stop] or [Resume] and press the **SET** button. (With a Bubble Jet printer, the print will automatically restart if the error is resolved.)

- **Direct Print Function Compatible Printers (CP Series)**

The Resume option may not appear with some types of error. In that case, select Stop.





- **Direct Print Function Compatible Bubble Jet Printers**

- The [Continue] and [Stop] options may appear with some error messages.
  - On Bubble Jet printers equipped with an operation panel, an error number displays on the panel. Please refer to the Bubble Jet Printer *Quick Start Guide* for the remedies corresponding to the error numbers.
-

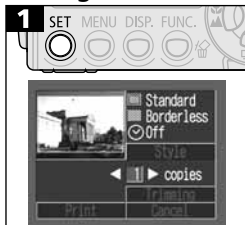
## Setting the Print Settings (Direct Print Function)

### Setting the Number of Print Copies









- Use the  or  button to select [Copies] and the  or  button to select the number. Up to 99 copies may be specified.

### Setting the Print Style





You can select from among the following print styles.

#### Direct Print Function Compatible Printer (CP Series)

 Image	 Standard	Prints one image per page.
	 Multiple*	Prints eight copies of the same image on one page.
 Borders	 Borderless	Prints right to the edges of the paper.
	 Bordered	Prints with a border.
<input checked="" type="checkbox"/> Date		Prints the image's creation date.

\* This option is only available for printing on card-size paper.

#### Bubble Jet Printer

 Paper		Select a paper size from the following: Card #1, Card #2, Card #3, LTR and A4. See the Bubble Jet printer's user guide for its media specifications.
 Borders	 Borderless	Prints right to the edges of the paper.
	 Bordered	Prints with a border.
<input checked="" type="checkbox"/> Date		Prints the image's creation date.



If you are using a direct print function compatible printer (CP series), the date and borders settings cannot be selected when the Multiple option is selected. (Images are printed without a date or border.)

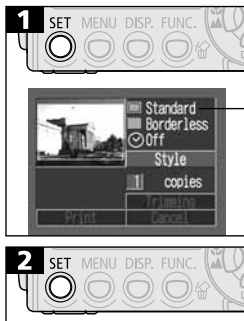

Current print style selection

- Use the or button to select [Style].

- Use the or button to select , , , or and the or button to select an option.



#### (Image Settings)

Direct Print Function Compatible Printer (CP Series)  
Select [Standard] or [Multiple].

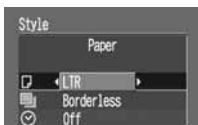

#### (Paper)

BJ Printer  
Select [Card #1], [Card #2], [Card #3], [LTR] or [A4].



#### (Borders)

Select [Borderless] or [Bordered].



#### (Date)

Select [On] or [Off].



- Press the **MENU** button to finish the procedure.
- Practically all of the image area is printed on bordered prints.
- With borderless or multiple prints, the image is printed with its top, bottom and sides trimmed.



The date settings are overridden by the DPOF print settings if you are using them to print (p. 114).



## Setting the Printing Area (Trimming)

You can print a portion of an image.

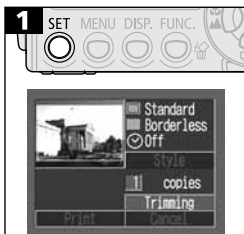

The shape of the trimming frame is determined by the print style selection (image, paper, borders, date). Set the print style before setting the printing area (p. 107).





- Use the  or  button to select [Trimming].







Trimming Frame

### Changing the Size of the Trimming Frame

- Press the zoom lever toward **Q** or .
- The trimming frame can be resized to approximately half the image size at minimum and practically as large as the image at maximum.
- You can cancel the trimming setting by sliding the zoom lever toward the  again when the trimming frame is already set to the maximum size.
- When printing an image that has been magnified using the trimming option, the image quality may become coarser and grainier depending on the magnifying rate. With direct print function compatible printers, the trimming frame displays in red.

### Moving the Trimming Frame

- Use the , ,  or  button to set the trimming frame's position.

### Rotating the Trimming Frame

- Press the **DISP.** button to rotate the trimming frame.



- The trimming frame will appear on images that have already had one assigned.
- Trimming settings can only be set for one image.
- Trimming settings are canceled with the following operations:
  - When the **MENU** button is pressed.
  - When the trimming settings are set for another image.
  - When the print mode is closed (camera power shut off, mode dial turned, or direct interface cable detached).
  - When the zoom lever is pressed further toward  with the trimming frame at its maximum.



## Setting the DPOF Print Settings

You can select images on a CF card for printing and specify the number of print copies in advance using the camera. This is extremely convenient for sending the images to a photo developing service or for printing on a direct print compatible printer (CP series) or a direct print compatible Bubble Jet printer.

### Selecting Images for Printing

There are two ways to select images.

- Singly
- All images on a CF card (the number of print copies is set to one per image)

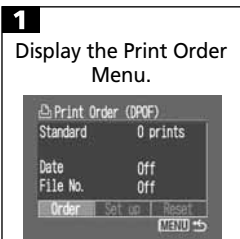

- See *Print Menu Settings* (p. 100).

- Use the or button to select [Print Order].





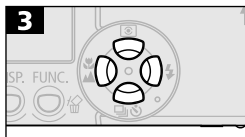

## Single Images

- As shown below, selection methods differ according to the options chosen for the  (Print Type) settings (p. 107).







### (Standard) / (Both)

- Use the  or  button to select an image and the  or  button to select the number of print copies (up to maximum of 99).

Number of Print Copies



### (Index)

- Use the  or  button to move to an image and the  or  button to select or deselect it. A checkmark displays on selected images.

Selected for  
an Index Print



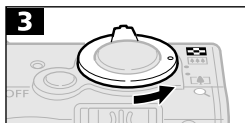

- You can use the same procedures to select images in index replay (3 images). Press the zoom lever toward  to switch between single image replay and index replay.
- Press the **MENU** button repeatedly until the replay screen reappears to complete the procedure.

## All the Images on a CF Card

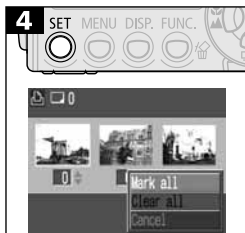

- Switch to index replay (3 images).



- Use the  or  button to select [Mark all].
- Selecting [Mark all] selects all of the card's images.



- Press the **SET** button to set the number of print copies to 1 for each image.
- When the print type is set to Standard or Both, the number of print copies can be set individually for each image. When Index is selected, the print settings can be deleted (p. 112).



- Press the **MENU** button repeatedly until the replay screen reappears to complete the procedure.



- The  symbol will display on images that have had print settings set by other DPOF-compliant cameras. These settings will be overwritten by those set by your camera.
- The output of some printers or photo developing services may not reflect the specified print settings.
- Print settings cannot be set for movie images.



- Images are printed in order from oldest to newest by the shooting date.
- A maximum of 998 images can be selected per CF card.
- When [Both] is selected, the number of print copies can be set, but it applies to Standard prints only. The Index setting only produces one print copy.
- Print settings can also be assigned to images with the bundled software on a computer.

## Setting the Print Style

Set the print style after selecting the image to print.  
The following print settings can be selected.

Print Type	<input checked="" type="checkbox"/> Standard	Prints one image per page.
	<input type="checkbox"/> Index	Prints the selected images together at a reduced size in an index format.
	<input type="checkbox"/> Both	Prints the images in both the standard and index formats.
<input checked="" type="checkbox"/> Date	Adds the date to the print.	
<input type="checkbox"/> File No.	Adds the file number to the print.	

**1**

Display the Print Order Menu.

**2**

SET MENU DISP. FUNC.



- See *Print Menu Settings* (p. 100).
- Use the or button to select [Set up].

- Use the or button to select or , and the or button to select an option.



### (Print Type)

- Select [Standard], [Index] or [Both].



### (Date)

- Select [On] or [Off].



### (File No.)

- Select [On] or [Off].



- Press the **MENU** button repeatedly until the replay screen reappears to complete the procedure.



The date prints as the date and time in the format specified in the Date/Time menu (p. 23).



When the print type is set to [Index], only one or the other of the [Date] and [File No.] options can be set to [On] at the same time.

## Resetting the Print Settings

The print settings can all be removed at once. The print type resets to Standard and the Date and File No. options to Off.

**1**

Display the Print Order Menu.



- See *Print Menu Settings* (p. 100).

- Use the or button to select [Reset].

**2**

SET MENU DISP. FUNC.

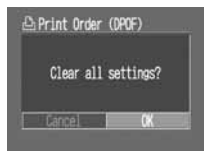

- Use the or button to select [OK].
- To exit without resetting, select [Cancel].

**3**

SET MENU DISP. FUNC.



## Printing with DPOF Print Settings

The DPOF print settings can be used to print on a direct print function compatible printer (CP series) or a direct print function compatible Bubble Jet printer.

**1**

Display the Print Order Menu.

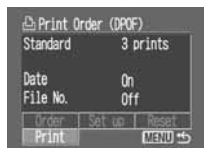

- See *Print Menu Settings* (p. 100).
- Use the button to select [Print].

**2**

SET MENU DISP. FUNC.



- Set the print style as required (p. 107).
- The print style cannot be set for images that have had the print type set to Index in the DPOF print settings. (You can also select the type of paper when printing with a Bubble Jet printer.)
- Use the buttons to select [OK].

**3**

SET MENU DISP. FUNC.

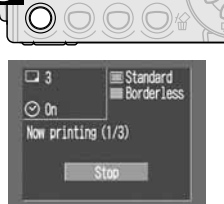

- Press the **SET** button to start printing.
- The replay screen will reappear when printing is successfully concluded.



- To include the date in the prints, set the Date setting in the Set up menu in Step 1 above to [On]. You cannot set the date to print with the Style menu in Step 2 above. Please note however, that the date will not print if the print type is set to Index even if it is turned On in Step 1.
- When the print type is set to [Both], it is possible to have both the [Date] and [File No.] options set to [On], but only the file number will print on the Index print. (Bubble Jet printers cannot print the date or file number on Index prints.)
- When the print type is set to [Standard], file numbers will not be printed even if they are set to [On].



- The maximum number of images printed on one page in the Index print type depends upon the selected paper size.
  - Card Size: 20 images
  - L Size: 42 images
  - Postcard Size: 63 images
 (Please refer to your Bubble Jet Printer *Quick Start Guide* for an explanation of the number of images printed with a Bubble Jet Printer)

- **Canceling Printing**

See page 106.

- **Restarting Printing**

In the Print Order menu, use the (⏪) or (⏩) button to select [Resume] and press the SET button. The remainder of the selected images will print.

Printing cannot be resumed under the following circumstances:

- If the print settings were changed before printing is restarted,
- If images with print settings were deleted before printing is restarted,
- If there was insufficient spare capacity on the CF card when printing was halted.

Under these circumstances, you can select [OK] in the Print menu and reprint starting from the first image.

If printing was stopped because of a low battery charge, you are recommended to resume printing using the AC Adapter Kit ACK500 (sold separately). If you do use a battery pack, ensure that it is fully charged. Remember to turn the camera power on again before printing.

- **Printing Errors**

See page 106.



## Image Transmission Settings (DPOF Transfer Order)

You can use the camera to specify settings for images that you wish to send by email. Please use the software supplied with the camera to actually transfer the images to an email program. Please read the *Software Starter Guide* for image transfer instructions.

The settings used on the camera comply with the Digital Print Order Format (DPOF) standards.



The  symbol will display on images that have had print settings set by other DPOF-compliant cameras. These settings will be overwritten by those set by your camera.

### Selecting Images for Transferring

1

In the  (Play) menu, select .

- See *Selecting Menus and Settings* (p. 38).



2







- The Transfer Order menu will display.

3

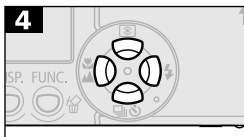



- Use the  or  button to select [Order].
- Pressing [Reset] cancels the transfer settings for all images on the CF card.



- Use the  or  button to move to an image and the  or  button to select or deselect it. A checkmark displays on selected images.

Selected for Transfer



- You can use the same procedures to select images in index replay (3 images). Press the zoom lever toward  to switch between single image replay and index replay.
- While in index replay, you can select all of the images by pressing the **SET** button, using the  or  button to select [Mark all] and pressing the **SET** button again.
- Press the **MENU** button to complete the transfer settings and redisplay the Transfer Order menu.





- Images are transferred in order from oldest to newest by the shooting date.
- A maximum of 998 images can be selected per CF card.

## Shooting/Replaying with a TV

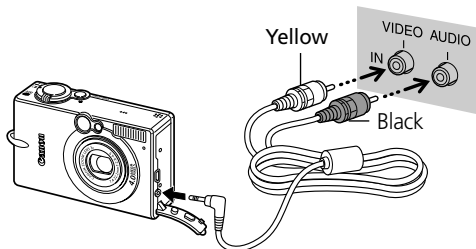
You can use a video-compatible television as a monitor to shoot or replay images when it is connected to the camera with the supplied AV Cable AVC-DC100. You must shut the TV and camera power off before you attach or detach the AV cable.



- After you have attached the AV cable at both ends, turn on the TV and set its TV/Video switch to Video.
- Set the mode switch to  or  and turn the camera power on. You can shoot or replay images using the normal procedures.
- If the images are not appearing on the TV when shooting, press the **DISP.** button.



- A TV set cannot be used in  mode.
- No image will appear on the LCD monitor when the camera is connected to a TV.
- If the TV is a stereo model, you can plug the audio plug into either the left or right Audio In jack. Please refer to the TV's manual for details.



The video output signal can be switched (NTSC or PAL) to accommodate different regional standards. The default setting varies between regions.

NTSC: Japan, U.S.A., Canada, Taiwan, etc.

PAL: Europe, Asia (excluding Taiwan), Oceania, etc.

If the video system is set incorrectly, the camera output may not display properly.

## Downloading Images to a Computer

Download images taken with the camera to a computer in one of the following ways:

- **Connect the camera to a computer with the USB cable**  
You can then download images directly from the camera to a computer.
- **Directly from the CF card**  
Using a laptop computer or a card reader, you can download images directly from the CF card.

### Connecting the Camera to a Computer via the USB cable

After the software is installed, you can use it to easily download images and print them or send them by email.

#### IMPORTANT

You must install the software and driver bundled on the supplied Canon Digital Camera Solution Disk onto your computer if you are using any of the following operation systems:  
Windows 98 (including Second Edition) / Windows 2000 / Windows Me  
Mac OS 9.0 - 9.2



The camera will not operate correctly if you connect it to your computer before installing the driver and software. If this happens, please refer to the *Troubleshooting* section of the *Software Starter Guide*.

**1**

Install the driver and the software applications bundled on the Canon Digital Camera Solution Disk.  
Please see the *Software Starter Guide* for information on system requirements and installation instructions.

- 2** Connect the supplied USB interface cable to the computer's USB port and the camera's DIGITAL terminal.

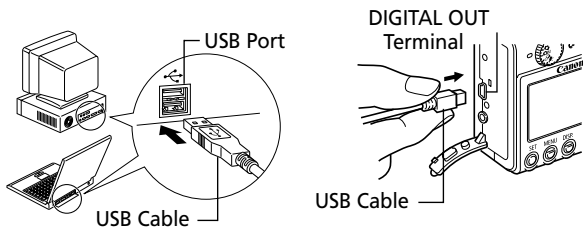

- 1** Slip a fingernail under the upper edge of the terminal cover to open it.
- 2** Insert the connector until it clicks.



- You do not need to turn off the computer or camera when making a USB connection.
- Please refer to your computer's manual for information regarding the location of the USB port.

- 3** Set the camera's mode switch to the  position and turn the camera's power on.

The LCD monitor will turn on in replay mode and then blank out when the connection to the computer is complete.

Please refer to the *Software Starter Guide* for the subsequent procedures.

### Downloading Images without Installing the Software (Windows XP and Mac OS X (v10.1/10.2) only)

If you are using the Windows XP or Mac OS X (v10.1/10.2), you can use the software distributed with these operating systems to download images (JPEG format only) without installing the software bundled on the Canon Digital Camera Solution Disk. This is useful for downloading images to a computer in which the software is not installed.

However, please note that there are certain limitations to downloading with this method.

For more details, please refer to the supplied *For Windows XP and Mac OS X Users* leaflet.

1. Connect the supplied USB interface cable to the computer's USB port and the camera's DIGITAL terminal. (Refer to step 2 on page 123).
2. Follow the onscreen instructions to download the images.



- Ensure that you grip the connector's sides when you detach the cable from the camera's DIGITAL terminal.

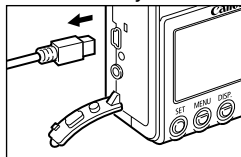

- It is recommended to power the camera from a household power outlet with the optional AC adapter Kit ACK500 when connected to a computer (p. 141).
- If the USB cable is detached while the camera power is on, the camera will power down.
- All procedures performed with a connection to a USB 2.0 compliant board are not guaranteed.

## Downloading Directly from a CF Card

Images can be loaded directly from a CF card if you have a slot-equipped notebook computer, a PC card reader or a CF card reader.

- 1** Eject the CF card from the camera and insert it into a CF card reader connected to the computer.

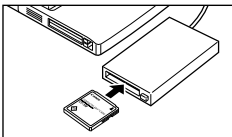

If you are using a PC card reader, first insert the CF card into a PC card adapter (sold separately), and then insert the PC card adapter into the computer's PC card reader.

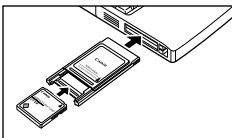













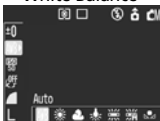



- 2** Double-click the icon of the drive containing the CF card.
- 3** Copy the CF card's images to the desired folder on the hard disk. The images are contained in the [XXXCANON] folder, which is a subfolder of the [DCIM] folder on the CF card. The XXX represents a number from 100 to 998.

# Lists of Menu Options and Messages

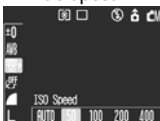
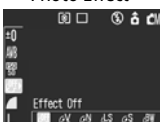

The following charts list the various menu contents. See *Selecting Menus and Settings* (p. 38) to learn how to select a setting.

## FUNC. Menu

\* Default setting

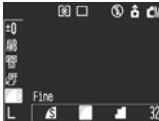

Item/Menu Screen	Options	Reference Page
<p>Exposure Compression</p> 	<p>Sets the exposure compression.</p> <ul style="list-style-type: none"> <li>• -2 to 0* to +2</li> </ul>	p. 70
<p>Long Shutter</p> 	<p>Sets the shutter speed.</p> <ul style="list-style-type: none"> <li>• 1* to 15 seconds</li> </ul>	p. 71
<p>White Balance</p> 	<p>Sets the white balance option.</p> <ul style="list-style-type: none"> <li>•  Auto*</li> <li>•  Daylight</li> <li>•  Cloudy</li> <li>•  Tungsten</li> <li>•  Fluorescent</li> <li>•  Fluorescent H</li> <li>•  Custom</li> </ul>	p. 73
<p>ISO Speed</p> 	<p>Sets the sensitivity at which images are recorded.</p> <ul style="list-style-type: none"> <li>• AUTO</li> <li>• 50*</li> <li>• 100</li> <li>• 200</li> <li>• 400</li> </ul>	p. 77
<p>Photo Effect</p> 	<p>Sets the photo effect.</p> <ul style="list-style-type: none"> <li>•  Effect Off*</li> <li>•  Vivid</li> <li>•  Neutral</li> <li>•  Low Sharpening</li> <li>•  Sepia</li> <li>•  BW</li> </ul>	p. 76









Item/Menu Screen	Options	Reference Page
<p>Compression</p> 	<p>Sets the relative compression ratio used for images.</p> <ul style="list-style-type: none"> <li>• <b>S</b> Superfine</li> <li>• <b>Fine*</b></li> <li>• <b>Normal</b></li> </ul>	p. 51
<p>Resolution (Stills)</p> 	<p>Sets the number of pixels used for images.</p> <ul style="list-style-type: none"> <li>• <b>L</b> (Large)* 2272 x 1704 pixels</li> <li>• <b>M1</b> (Medium 1) 1600 x 1200 pixels</li> <li>• <b>M2</b> (Medium 2) 1024 x 768 pixels</li> <li>• <b>S</b> (Small) 640 x 480 pixels</li> </ul>	p. 51
<p>Resolution (Movies)</p> 	<p>Sets the number of pixels used for movies.</p> <ul style="list-style-type: none"> <li>• <b>320</b> 320 x 240 pixels*</li> <li>• <b>160</b> 160 x 120 pixels</li> </ul>	p. 51

## Rec. Menu





\* Default setting

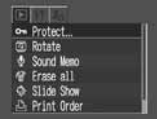
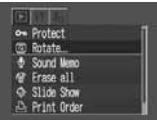

Item/Menu Screen	Options	Reference Page
<p>AiAF</p> 	<p>Sets whether or not the camera automatically select the AF frame or a fixed center AF frame.</p> <ul style="list-style-type: none"> <li>• On*</li> <li>• Off</li> </ul>	p. 68
<p>Cont. Shooting</p> 	<p>Sets the continuous shooting mode.</p> <ul style="list-style-type: none"> <li>• <b>Standard</b> continuous shooting*</li> <li>• <b>High-speed</b> continuous shooting</li> </ul>	p. 57

\* Default setting

Item/Menu Screen	Options	Reference Page
<p data-bbox="218 215 322 237">Self-timer</p> 	<p data-bbox="425 215 826 237">Sets the duration before the self-timer delay.</p> <ul data-bbox="425 244 595 307" style="list-style-type: none"> <li>•  10 seconds*</li> <li>•  2 seconds</li> </ul>	p. 58
<p data-bbox="192 404 342 426">AF-assist Beam</p> 	<p data-bbox="425 404 751 426">Sets the AF-assist Beam to on or off.</p> <ul data-bbox="425 441 487 496" style="list-style-type: none"> <li>• On*</li> <li>• Off</li> </ul>	p. 36
<p data-bbox="203 594 332 615">Digital Zoom</p> 	<p data-bbox="425 594 780 645">Sets whether or not the optical zoom is supplemented by digital processing.</p> <ul data-bbox="425 652 487 707" style="list-style-type: none"> <li>• On</li> <li>• Off*</li> </ul>	p. 56
<p data-bbox="234 783 306 805">Review</p> 	<p data-bbox="425 783 821 834">Sets the duration images display on the LCD monitor after the shutter button releases.</p> <ul data-bbox="425 841 800 896" style="list-style-type: none"> <li>• Off</li> <li>• 2*to 10 seconds (1-second increments)</li> </ul>	p. 50
<p data-bbox="203 972 332 994">Long Shutter</p> 	<p data-bbox="425 972 769 994">Sets the shutter speed to slow settings.</p> <ul data-bbox="425 1001 487 1057" style="list-style-type: none"> <li>• On</li> <li>• Off*</li> </ul>	p. 71





## Play Menu





Item/Menu Screen	Options	Reference Page
<p style="text-align: center;"><b>Protect</b></p> 	Protects images from accidental erasure.	p. 94
<p style="text-align: center;"><b>Rotate</b></p> 	Rotates images clockwise 90° or 270° in the display.	p. 87
<p style="text-align: center;"><b>Sound Memo</b></p> 	Adds sound memos to images.	p. 88
<p style="text-align: center;"><b>Erase all</b></p> 	Deletes all images from a CF card (except for protected images).	p. 96
<p style="text-align: center;"><b>Slide Show</b></p> 	Plays images in automated slide shows.	p. 90





Item/Menu Screen	Options	Reference Page
<p><b>Print Order</b></p> 	<p>Selects images and the number of print copies for output to a DPOF - compatible printer or a photo developing service.</p>	p. 111
<p><b>Transfer Order</b></p> 	<p>Selects the images that will be transferred to your email software.</p>	p. 119

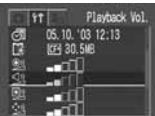

## Set up Menu

\* Default setting

Item/Menu Screen	Options	Reference Page
<p><b>Beep</b></p> 	<p>Sets whether or not a beep sounds when the shutter button is pressed.</p> <ul style="list-style-type: none"> <li>• On*</li> <li>• Off</li> </ul> <p>A beep still sounds to warn of errors even when Off is selected.</p>	p. 35
<p><b>LCD Brightness</b></p> 	<p>Adjusts the brightness of the LCD monitor.</p> <ul style="list-style-type: none"> <li>• -7 to 0* to +7</li> </ul> <p>Only the brightness adjustment bar displays if you press the <b>SET</b> button. If you press the  or  buttons, the display returns to the Set up menu. You can check the brightness in the LCD monitor while you are adjusting the setting.</p>	-

Item/Menu Screen	Options	Reference Page
<p><b>Auto Power Down</b></p> 	<p>Sets whether or not the camera automatically powers down after a set period of time elapses without something being pressed.</p> <ul style="list-style-type: none"> <li>• On*</li> <li>• Off</li> </ul>	p. 27
<p><b>Date/Time</b></p> 	Sets the date and time and the date format.	p. 23
<p><b>Format</b></p> 	Formats (initializes) CF cards.	p. 97
<p><b>Shutter Volume</b></p> 	<p>Adjusts the volume of the sound played when the shutter releases. The shutter sound does not play when a movie is recording.</p> <ul style="list-style-type: none"> <li>• □□□□ Off</li> <li>• ■□□□ 1</li> <li>• ■■□□ 2*</li> <li>• ■■■□□ 3</li> <li>• ■■■■□ 4</li> <li>• ■■■■■ 5</li> </ul>	p. 35
<p><b>Playback Vol.</b></p> 	<p>Adjusts the volume of movie sounds and sound memos.</p> <ul style="list-style-type: none"> <li>• □□□□ Off</li> <li>• ■□□□ 1</li> <li>• ■■□□ 2*</li> <li>• ■■■□□ 3</li> <li>• ■■■■□ 4</li> <li>• ■■■■■ 5</li> </ul>	p. 83 p. 88

Item/Menu Screen	Options	Reference Page
<p><b>Start-up Vol.</b></p> 	<p>Adjusts the volume of the start-up sound when the camera power is turned on.</p> <ul style="list-style-type: none"> <li>• □□□□ Off</li> <li>• □□□□ 1</li> <li>• ■□□□ 2*</li> <li>• ■■□□ 3</li> <li>• ■■■□ 4</li> <li>• ■■■■ 5</li> </ul>	p. 26
<p><b>Operation Vol.</b></p> 	<p>Adjusts the volume of the operation sound.</p> <ul style="list-style-type: none"> <li>• □□□□ Off</li> <li>• □□□□ 1</li> <li>• ■□□□ 2*</li> <li>• ■■□□ 3</li> <li>• ■■■□ 4</li> <li>• ■■■■ 5</li> </ul>	p. 35
<p><b>Selftimer Vol.</b></p> 	<p>Adjusts the volume of the self-timer sound played 2 sec. before shutter is released.</p> <ul style="list-style-type: none"> <li>• □□□□ Off</li> <li>• □□□□ 1</li> <li>• ■□□□ 2*</li> <li>• ■■□□ 3</li> <li>• ■■■□ 4</li> <li>• ■■■■ 5</li> </ul>	p. 58
<p><b>File No. Reset</b></p> 	<p>Sets how file numbers are assigned to images when new CF cards are inserted.</p> <ul style="list-style-type: none"> <li>• On</li> <li>• Off*</li> </ul>	p. 79
<p><b>Auto Rotate</b></p> 	<p>Sets whether or not images shot with the camera on end are automatically rotated in the display.</p> <ul style="list-style-type: none"> <li>• On*</li> <li>• Off</li> </ul>	p. 78

Item/Menu Screen	Options	Reference Page
<p data-bbox="215 180 319 205">Language</p> 	<p data-bbox="425 180 764 230">Sets the language used in menus and messages on the LCD monitor.</p> <ul data-bbox="425 234 684 404" style="list-style-type: none"> <li>• English*</li> <li>• Deutsch</li> <li>• Français</li> <li>• Nederlands</li> <li>• Dansk</li> <li>• Suomi</li> <li>• Italiano</li> <li>• Norsk</li> <li>• Svenska</li> <li>• Español</li> <li>• Chinese</li> <li>• Japanese</li> </ul> <p data-bbox="425 409 819 477">You can also change the language in replay mode by holding the <b>SET</b> button and pressing the <b>MENU</b> button.</p>	p. 25
<p data-bbox="203 489 339 513">Video System</p> 	<p data-bbox="425 489 764 513">Sets the video output signal standard.</p> <ul data-bbox="425 518 498 579" style="list-style-type: none"> <li>• NTSC</li> <li>• PAL</li> </ul>	p. 121

























## My Camera Menu



You can select the start-up image and sound, shutter sound, operation sound and selftimer sound used on this camera. These are called the My Camera settings. You can also customize the **Q2** and **Q3** options for each item with images recorded on the CF card and newly recorded sounds or by using the supplied software. See the *Software Starter Guide* for details.

\* Default setting

Item/Menu Screen	Options	Reference Page
<p data-bbox="234 1068 306 1093">Theme</p> 	<p data-bbox="425 1068 767 1118">Selects a common theme for each My Camera settings item.*1</p> <ul data-bbox="425 1122 526 1243" style="list-style-type: none"> <li>• <b>Q6</b> Off</li> <li>• <b>1</b> *</li> <li>• <b>Q2</b></li> <li>• <b>Q3</b></li> </ul>	p. 45



\*1 For more information, see *How the Beep in the **ff** (Set up) Menu and Sounds in the **Q6** (My Camera) Menu Interact* (p. 135).

Item/Menu Screen	Options	Reference Page
<p>Start-up Image</p> 	<p>Sets the image displayed when the camera power is turned on.</p> <ul style="list-style-type: none"> <li>•  Off</li> <li>•  *</li> <li>•  *</li> <li>•  *</li> </ul>	p. 45
<p>Start-up Sound</p> 	<p>Sets the sound emitted when the camera power is turned on.*<sup>1</sup></p> <ul style="list-style-type: none"> <li>•  Off</li> <li>•  *</li> <li>•  *</li> <li>•  *</li> </ul>	p. 45
<p>Operation Sound</p> 	<p>Sets the sound emitted when any button other than the shutter button is pressed.*<sup>1</sup></p> <ul style="list-style-type: none"> <li>•  Off</li> <li>•  *</li> <li>•  *</li> <li>•  *</li> </ul>	p. 45
<p>Selftimer Sound</p> 	<p>Sets the sound emitted 2 seconds before the shutter releases in self-timer mode.*<sup>1</sup></p> <ul style="list-style-type: none"> <li>•  Off</li> <li>•  *</li> <li>•  *</li> <li>•  *</li> </ul>	p. 45
<p>Shutter Sound</p> 	<p>Sets the sound emitted when the shutter button is pressed. There is no shutter sound for movies.*<sup>1</sup></p> <ul style="list-style-type: none"> <li>•  Off</li> <li>•  *</li> <li>•  *</li> <li>•  *</li> </ul>	p. 45













\*<sup>1</sup> For more information, see *How the Beep in the  (Set up) Menu and Sounds in the  (My Camera) Menu Interact* (p. 135).



## How the Beep in the (Set up) Menu and Sounds in the (My Camera) Menu Interact

To turn off each sound, such as the start-up sound, shutter sound, operation sound and selftimer sound, the beep must first be set to [Off] in the  (Set up) menu and then each sound item must be set individually to [Off]. If the beep is set to [On], a beep will sound for each item even if it is set to [Off] in the  (My Camera) menu.

The table below shows the relationship.

		Beep Settings in the  (Set up) Menu	
		On	Off
Sounds in the  (My Camera) Menu (Start-up, shutter, operation, self-timer)		● (Beep)	— (Off)
		● (  )	● (  )
		● (  )	● (  )
		● (  )	● (  )

- Sound emitted
- Sound not emitted

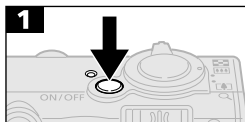

## Resetting Settings to Their Default Values

You can reset the menu and button settings to the default settings in one operation except for the Date/Time, Language and Video System settings.

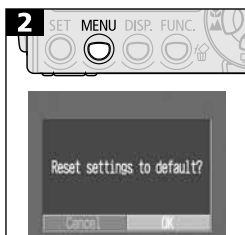

- Press the ON/OFF button until the green power lamp lights.
- Set the mode switch to any position.



- Press and hold the **MENU** button for more than 5 seconds.
- Use the  or  button to select [OK].
- To exit without resetting, select [Cancel].



- White balance data recorded with the custom white balance function is not reset by this function (p. 74).
- Settings cannot be reset when the camera is connected to a computer, to a direct print function compatible printer (CP series, optional) or to a direct print function compatible BJ printer (optional).

## List of Messages

The following messages may appear on the LCD monitor while shooting or replaying.

<b>Busy...</b>	Image is being recorded to, or read from, CF card
<b>No memory card</b>	You attempted to shoot or replay images without a CF card installed.
<b>Cannot record!</b>	You attempted to shoot an image without a CF card installed.
<b>Memory card error!</b>	CF card has experienced an anomaly.
<b>Memory card full</b>	CF card is too full to accommodate more images or print settings.
<b>Naming error!</b>	The file could not be created because there is a file with the same name as the directory that the camera is attempting to create, or the highest possible file number has already been reached. In the Rec. Menu, set the File Reset option to On. Save all the images you wish to retain onto a computer, then reformat the CF card. Please note that formatting will erase all the existing images and other data.
<b>Change the battery pack</b>	Battery charge is insufficient to operate the camera. Replace it at once with a charged one or recharge the battery pack.
<b>No image</b>	No images recorded on CF card.
<b>Image too large</b>	You attempted to replay an image larger than 3200 x 2400 pixels or with a large file size.
<b>Incompatible JPEG format</b>	You attempted to replay an incompatible JPEG file.

Corrupted Data	You attempted to replay an image with corrupted data.
RAW	You attempted to replay an image recorded in the RAW format.
Unidentified Image	You attempted to replay an image that was recorded in a special format (proprietary format used by the camera of another manufacturer, etc.) or a movie clip recorded by another camera.
Cannot magnify!	You attempted to magnify an image which was photographed with another camera, recorded in a different format, or edited on a computer.
Cannot rotate	You attempted to rotate an image which was photographed with another camera, recorded in a different format, or edited on a computer.
Incompatible WAVE format	A sound memo cannot be added to this image since the format of the existing sound memo is incorrect.
Cannot register this image!	You attempted to add a start-up image that was created with another camera.
Protected!	You attempted to erase a protected image.
Too many marks	Too many images have been marked with print settings, transfer settings or slide show settings. Cannot process any more.
Unselectable image	You attempted to set the print settings for a non-JPEG file.
Exx:	(xx: number) Camera malfunction. Turn the power off and then back on, then shoot or replay. A problem exists if the error code reappears. Note the number and contact your Canon Customer Support Help Desk. If an error code displays directly after taking a picture, the shot may not have been recorded. Check image in replay mode.

### List of Messages Displayed while a Direct Print Function Compatible Printer (CP series) is Connected

The following messages may appear on the camera's LCD monitor while a direct print function compatible printer (sold separately) is connected.

No Paper	Paper cassette is empty or incorrectly installed. Paper feed may not be operating correctly.
No Ink	The ink cassette is empty or missing.
Incompatible paper size	You attempted to print with a paper size incompatible with this camera.
Incompatible ink size	You attempted to print with an ink cartridge type incompatible with this camera.
Ink Cassette Error	There is a problem with the ink cassette.
Paper and ink do not match	The paper and ink are from different sets.
Paper Jam	Paper jammed during printing.
Paper has been changed	The paper size was changed between the time the Print Style menu was displayed and the time printing started.
Recharge the printer battery	The printer's battery is out of power.
Communication Error	A communication error has occurred.
Readjust trimming	You attempted to print the image with a different style than the one used when the trimming settings were set.
Cannot print!	You attempted to print an image shot by a different camera, one recorded in an incompatible format, or one downloaded to and edited with a computer.
Could not print XX images	You attempted to print XX number of images with DPOF print settings that were shot by a different camera, recorded in an incompatible format, or downloaded to and edited with a computer.

### List of Messages Displayed while a Direct Print Function Compatible Bubble Jet Printer is Connected

The following messages may appear on the camera's LCD monitor while a direct print function compatible Bubble Jet printer (sold separately) is connected.

On Bubble Jet Printers with operation panels, check the error number displayed on the panel and refer to the Bubble Jet Printer *Quick Start Guide*.

Printer in use	Printer is busy printing from a memory card in computer or printer. Printer will automatically start printing from camera when the current print queue empties.
Printer warming up	Printer is warming up. When it is ready, the printer will start printing automatically.
No printhead	No printhead installed in printer.
Printer cover open	Secure the printer front cover.
Media type error	You selected a paper type incompatible with the printer. Select a compatible paper type in the Print Style menu.
Paper lever error	Adjust the paper thickness lever to the proper position.
Low ink level	Ink tank needs replacement soon. Prepare a new ink tank. Select [Continue] in the error message to resume printing. (This message will not appear on some models.)
Waste tank full	Restart printing by pressing RESUME/CANCEL button on printer, but request a replacement waste ink tank from a service center (see printer <i>Quick Start Guide</i> or the Contact List provided with the printer) soon.
Printer error	Turn printer off and on again. If error persists, consult service center listed in printer <i>Quick Start Guide</i> or in the Contact List provided with the printer.

## Appendices

### Using an AC Adapter Kit (Sold Separately)

It is best to power the camera with AC Adapter Kit ACK500 (sold separately) when you are using it for long periods of time or connecting it to a computer.



Turn the camera power off before connecting or disconnecting the AC adapter.

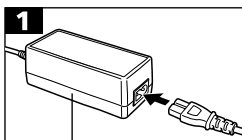

**1**  
Compact Power Adapter  
CA-PS500

- Connect the power cord to the compact power adapter first and then plug the other end into the power outlet.

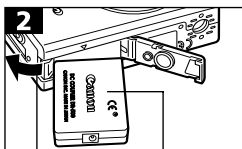

**2**  
Battery Lock      DC Coupler  
                         DR-500

- Open the battery cover and press the battery lock in the direction shown while inserting DC Coupler DR-500. Insert the DC coupler all the way in until the battery lock clicks. Slide the battery cover closed.

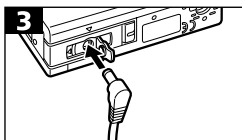

**3**

- Open the DC coupler terminal cover and attach the cord to the DC terminal.
- After you have finished using the camera, unplug the AC adapter from the power outlet.



Use of an AC adapter kit other than ACK500 may cause a malfunction in the camera or kit.

## Using a Car Battery Charger (optional)

Car Battery Charger CBC-NB1 (sold separately) can be used to charge battery packs from an automobile's cigarette lighter socket.



Always ensure that the automobile's engine is running when you use the car battery charger. Use of it with the engine off may flatten the battery in some automobiles. Always unplug the car battery charger before turning off the engine.

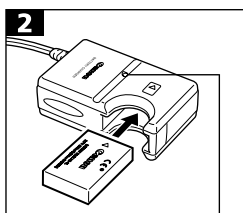
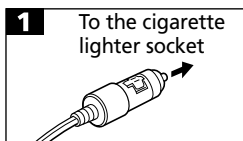

Charge Indicator

- With the engine running, plug the car battery cable into the cigarette lighter socket and the battery charger.
- Insert the battery pack all the way into the battery charger as shown.
- The charge indicator will light red while the battery pack is charging. It will change to green when the charge is complete.
- After charging, unplug the car battery cable from the cigarette lighter socket and remove the battery pack.



- The battery will stop charging whenever you turn the engine off, so be sure to unplug the car battery cable from the cigarette lighter socket.
- Wait until the engine is running again to plug the car battery cable into the cigarette lighter socket.
- The car battery charger can only be used in a negative ground car. It cannot be used in a positive ground car.



## Camera Care and Maintenance

Use the following procedures to clean the camera body, lens, viewfinder and LCD monitor.



---

Never use thinners, benzene, synthetic cleansers or water to clean the camera. These substances may distort or damage the equipment.

---

### Camera Body

Gently wipe dirt off the camera body with a soft cloth or eyeglass lens wiper.

### Lens

First use a lens blower brush to remove dust and dirt, then remove any remaining dirt by wiping the lens lightly with a soft cloth.



- Never use synthetic cleansers on the camera body or lens.
  - If dirt remains, contact the closest Canon Customer Support Help Desk as listed on the separate Canon Customer Support leaflet.
- 

### Viewfinder and LCD Monitor

Use a lens blower brush to remove dust and dirt. If necessary, gently wipe with a soft cloth or an eyeglass lens wiper to remove stubborn dirt.





---

Never rub or press strongly on the LCD monitor. These actions may damage it or lead to other problems.



---

## Troubleshooting

Problem	Cause	Solution
Camera will not operate	Power is not turned on	<ul style="list-style-type: none"> <li>• Press the ON/OFF button for a moment.</li> </ul>
	Battery cover or CF card slot cover is open	<ul style="list-style-type: none"> <li>• Confirm that the battery cover and CF card slot cover are securely closed.</li> </ul>
	Insufficient battery voltage	<ul style="list-style-type: none"> <li>• Insert a fully charged battery into the camera.</li> <li>• Use the AC Adapter Kit ACK500 (sold separately).</li> </ul>
	Poor contact between camera and battery terminals	<ul style="list-style-type: none"> <li>• Wipe the terminals with a clean dry cloth.</li> </ul>
Camera will not record	Mode switch is set to  (Replay)	<ul style="list-style-type: none"> <li>• Set the mode switch to .</li> </ul>
	Flash is charging	<ul style="list-style-type: none"> <li>• Wait until the flash charges. You can press the shutter button when the indicator lights orange.</li> </ul>
	CF card is full	<ul style="list-style-type: none"> <li>• Insert a new CF card.</li> <li>• If required, download the images to a computer and erase them from the CF card to make space.</li> </ul>
	CF card is not formatted correctly	<ul style="list-style-type: none"> <li>• Format CF card (See <i>Formatting CF Cards</i> p. 97).</li> <li>• If reformatting doesn't work, the CF card logic circuits may be damaged. Consult the nearest Canon Customer Support Help Desk.</li> </ul>

Problem	Cause	Solution
Lens will not retract	Battery cover or CF card slot cover was opened with power on	<ul style="list-style-type: none"> <li>• First close the battery cover or CF card slot cover and then turn the power off.</li> </ul>
	Battery cover or CF card slot cover was opened while recording to the CF card (warning signal sounds)	<ul style="list-style-type: none"> <li>• First close the battery cover or CF card slot cover and then turn the power off.</li> </ul>
Battery pack consumed quickly	Battery life exceeded if battery pack loses its charge quickly at normal temperature (23° C / 73° F)	<ul style="list-style-type: none"> <li>• Replace the battery pack with a new one.</li> </ul>
Battery pack will not charge	Battery pack life exceeded	<ul style="list-style-type: none"> <li>• Replace the battery pack with a new one.</li> </ul>
	Poor contact between battery pack and battery charger	<ul style="list-style-type: none"> <li>• Insert battery pack securely into battery charger.</li> <li>• Ensure that battery charger plug is securely plugged into the power outlet.</li> </ul>
Image is blurred or out of focus	Camera moved	<ul style="list-style-type: none"> <li>• Be careful not to move the camera while pressing the shutter button.</li> </ul>
	Autofocus function hampered by obstruction to AF-assist Beam	<ul style="list-style-type: none"> <li>• Be careful not to block the AF-assist Beam with fingers or other items.</li> </ul>

Problem	Cause	Solution
Image is blurred or out of focus	AF-assist Beam is set to off	<ul style="list-style-type: none"> <li>• Set the AF-assist Beam to on (p. 128).</li> </ul>
	Subject is out of focal range	<ul style="list-style-type: none"> <li>• Ensure there is at least 46 cm (1.5 ft.) between the camera lens and subject.</li> <li>• Use the Macro mode to shoot close-ups between 30 and 46 cm (11.8 in. to 1.5 ft.) from the lens (5 cm (2 in.) when set to wide angle).</li> <li>• Use the Infinity mode to shoot distant subjects.</li> </ul>
	The subject is hard to focus on	<ul style="list-style-type: none"> <li>• Use the focus lock to shoot. See <i>Locking the Focus (AF Lock)</i>.</li> </ul>
Subject in recorded image is too dark	Insufficient light for shooting	<ul style="list-style-type: none"> <li>• Set the flash to on.</li> </ul>
	Subject is dark in contrast to the background	<ul style="list-style-type: none"> <li>• Set the exposure compensation to a positive (+) setting or use the spot metering function.</li> </ul>
	Subject is too far away for flash to reach	<ul style="list-style-type: none"> <li>• Shoot within 3.5 m (11.5 ft.) of the subject at the maximum wide angle or 2 m (6.6 ft.) of the subject at the telephoto end setting when using the flash.</li> </ul>
Subject in recorded image is too bright	Subject is too close, making the flash too strong	<ul style="list-style-type: none"> <li>• When using the flash, stay at least 30 cm (11.8 in.) from the subject.</li> </ul>
	Subject is bright in contrast to the background	<ul style="list-style-type: none"> <li>• Set the exposure compensation to a negative (-) setting or use the spot metering function.</li> </ul>
	Light is shining directly on the subject or reflected off the subject into the camera	<ul style="list-style-type: none"> <li>• Change the shooting angle.</li> </ul>
	Flash is set to on	<ul style="list-style-type: none"> <li>• Set the flash to off.</li> </ul>

Problem	Cause	Solution
A red band appears on the LCD monitor	Subject is too bright	<ul style="list-style-type: none"> <li>This is a normal occurrence in devices containing CCDs and does not constitute a malfunction. (This red bar of light will not be recorded when shooting still photos, but it will be recorded when shooting movies.)</li> </ul>
White dots appear on the image	Light from the flash has reflected off dust particles or insects in the air. This occurs more frequently when shooting at the wide-angle end.	<ul style="list-style-type: none"> <li>This is a phenomenon that occurs with digital cameras and does not constitute a malfunction.</li> </ul>
Flash does not fire	Flash is set to off	<ul style="list-style-type: none"> <li>Set the flash to on.</li> </ul>
Image not showing on TV monitor	Incorrect video system setting	<ul style="list-style-type: none"> <li>Set the video system to the appropriate setting, NTSC or PAL, for your TV (p. 133).</li> </ul>
	Shooting mode set to  (Stitch Assist)	<ul style="list-style-type: none"> <li>The output will not appear on a TV in  (Stitch Assist) mode. Shoot in a different mode.</li> </ul>
Zoom does not work	Zoom lever pressed during movie recording	<ul style="list-style-type: none"> <li>Adjust the zoom before shooting a movie.</li> </ul>
Reading images from CF card is slow	CF card was formatted in another device	<ul style="list-style-type: none"> <li>Use a CF card formatted in your camera. See Formatting CF Cards (p. 97).</li> </ul>
Recording images to CF card takes a long time		

# Specifications

All data is based on Canon's standard testing methods.  
Subject to change without notice.

## PowerShot S400 DIGITAL ELPH / DIGITAL IXUS 400

Camera Effective Pixels:	Approx. 4 million
Image Sensor:	1/1.8 in. CCD (Total number of pixels: approx. 4.1 million)
Lens:	7.4 (W) - 22.2 (T) mm (35 mm film equivalent: 36-108mm) F2.8 (W) - 4.9 (T)
Digital Zoom:	Maximum approx. 3.6 x (Maximum approx. 11 x with optical zoom)
Optical Viewfinder:	Real-image optical zoom viewfinder
LCD Monitor:	1.5 in. low-temperature polycrystalline silicon TFT color LCD, Approx. 118,000 pixels
Autofocus:	TTL 9-point AiAF/TTL 1-point center AF Focus lock possible
Focusing Range:	Normal: 46 cm (1.5 ft.) - ∞ Macro AF: 5-46 cm (2.0 in. - 1.5 ft.) (W) 30-46 cm (11.8 in. - 1.5 ft.) (T)
Shutter:	Mechanical + electronic
Shutter Speed:	15- 1/2000 sec. <ul style="list-style-type: none"> <li>• 15- 1 sec. possible in long shutter mode</li> <li>• Noise reduction processing on speeds between 15- 1.3 sec.</li> </ul>
Light Metering System:	Evaluative metering/Center-weighted averaging/Spot metering
Exposure Control:	Program AE
Exposure Compensation:	+/- 2 stops in 1/3-stop increments
Sensitivity:	Auto/ISO 50/100/200/400 equivalents
White Balance:	TTL auto/preset (daylight, cloudy, tungsten, fluorescent, fluorescent H) or custom white balance
Flash:	Red-eye reduction auto/auto/on/off/slow-synchro

(W): wide angle (T): telephoto

Flash Shooting Range:	Normal mode: 46 cm-3.5 m (1.5-11.5 ft.) (W) 46 cm-2.0 m (1.5-6.6 ft.) (T) Macro Mode: 30-46 cm (11.8 in.-1.5 ft.) (W/T)
Shooting Modes:	Auto/manual/stitch assist/movie
Continuous Shooting:	Approx. 1.5 images/sec. (2.5 images/sec. in high-speed mode) (Large/Fine mode, LCD monitor off)
Self-timer:	Shoots after approx. 10 sec. or approx. 2 sec.
PC Connected Shooting:	Available (USB connection only. Exclusive software program "RemoteCapture" is included in the camera kit.)
Recording Media:	CompactFlash™ card (Type I)
File Format:	Design rule for Camera File System, DPOF-compliant
Image Recording Format	Still images: JPEG (Exif 2.2)* <sup>1</sup> Movies: AVI - Image data: Motion JPEG - Audio data: WAVE (monaural)
Compression:	Superfine/fine/normal
Number of Recording Pixels:	Still images: large 2272 x 1704 pixels medium 1 1600 x 1200 pixels medium 2 1024 x 768 pixels small 640 x 480 pixels Movies: 320 x 240 pixels (Approx. 3 min.) 160 x 120 pixels (Approx. 3 min.) Approx. 15 frames/sec. • The data in parentheses refer to the maximum movie length per clip.
Replay Modes:	Single image view/index view (9 thumbnails)/zoomed view (LCD monitor zooms images up to 10 x)/slide show/printing with Card Photo Printer CP-100, CP-10 or Bubble Jet Printer (Direct Print)
Display Languages:	English, Deutsch, Français, Nederlands, Dansk, Suomi, Italiano, Norsk, Svenska, Español, Chinese and Japanese
My Camera Settings (Customizing):	Start-up image, start-up sound, shutter sound, operation sound and selftimer sound can be customized with the following procedures. 1. Using the images and sounds recorded on the camera. 2. Using the downloaded data from your computer using the supplied software.

(W): wide angle (T): telephoto

Interface:	USB (mini-B, PTP [Picture Transfer Protocol]), Audio/Video output (NTSC or PAL selectable, Monaural audio)
Power Source:	Rechargeable Lithium-ion battery (type: NB-1LH/NB-1L) AC Adapter Kit ACK500 Car Battery Charger CBC-NB1
Operating Temperatures:	0°- 40° C (32°- 104° F)
Operating Humidity:	10% - 90%
Dimensions (w x h x d):	87.0 x 57.0 x 27.8 mm (3.4 x 2.2 x 1.1 in.) (excluding protrusions)
Weight:	Approx. 185 g (6.5 oz.) (camera body only)

\*1 This digital camera supports Exif 2.2 (also called "Exif Print"). Exif Print is a standard for enhancing the communication between digital cameras and printers. By connecting to an Exif Print-compliant printer, the camera's image data at the time of shooting is used and optimized, yielding extremely high quality prints.

## Battery Capacity

### Battery Pack NB-1LH (fully charged)

Number of recordable images	LCD monitor on	Approx. 190 images
	LCD monitor off	Approx. 440 images
Replay		Approx. 140 minutes















- Excludes movie data.
- At low operating temperatures, the battery performance may drop and the low battery icon may appear sooner than at high temperature. To improve performance at these temperatures, warm the battery in your pocket just before using it in the camera.





### Test Criteria

- Shooting:** Normal temperature (23° C/73° F), alternating between wide angle and telephoto every 20 seconds, flash used once in four shots, power turned off and on again after every eighth shot, LCD monitor set to default brightness.
- Replaying:** Normal temperature (23° C/73° F), continuous replay at 3 seconds per image, LCD monitor set to default brightness.







## CF Cards and Estimated Capacities (Recordable Images)

		FC-16M	FC-32M	FC-64M	FC-128M	FC-256MH
<b>L</b> (2272 x 1704 pixels)		7	14	30	61	123
		13	27	54	110	222
		26	54	110	220	443
<b>M1</b> (1600 x 1200 pixels)		14	30	61	122	246
		26	54	109	219	440
		52	108	217	435	868
<b>M2</b> (1024 x 768 pixels)		25	53	107	215	431
		46	94	189	379	762
		84	174	349	700	1390
<b>S</b> (640 x 480 pixels)		58	120	241	482	962
		94	196	393	788	1563
		165	337	676	1355	2720
MOVIE	 (320 x 240 pixels)	44 sec.	91 sec.	183 sec.	368 sec.	735 sec.
	 (160 x 120 pixels)	118 sec.	242 sec.	486 sec.	973 sec.	1954 sec.

- The maximum movie clip length is approximately 3 min\*. The times shown are the maximum continuous recording times.
- **L** (Large), **M1** (Medium 1), **M2** (Medium 2), **S** (Small),  and  indicate the recording resolution.
-  (Superfine),  (Fine) and  (Normal) indicate the compression setting.
- The FC-256 MH CF card is not sold in some regions.

## Image File Sizes (Estimated)

Resolution	Compression		
			
<b>L</b> (2272 x 1704 pixels)	2002 KB	1116 KB	556 KB
<b>M1</b> (1600 x 1200 pixels)	1002 KB	558 KB	278 KB
<b>M2</b> (1024 x 768 pixels)	570 KB	320 KB	170 KB
<b>S</b> (640 x 480 pixels)	249 KB	150 KB	84 KB
Movies	 (320 x 240 pixels)	330 KB/sec.	
	 (160 x 120 pixels)	120 KB/sec.	

**CompactFlash™ Card**

Card Slot Type:	Type I
Dimensions:	36.4 x 42.8 x 3.3 mm (1.4 x 1.7 x 0.1 in.)
Weight:	Approx. 10 g (0.4 oz.)

**Battery Pack NB-1LH**

Type:	Rechargeable Lithium Ion Cell
Nominal Voltage:	3.7 V
Typical Capacity:	840 mAh
Cycle Life:	Approx. 300 times
Operating Temperatures:	0-40 °C (32-104 °F)
Dimensions:	32.3 x 49.8 x 10.6 mm (1.3 x 2.0 x 0.4 in.)
Weight:	Approx. 29 g (1.0 oz.)

**Battery Charger CB-2LS/CB-2LSE**

Rated Input:	100-240 V AC (50/60 Hz) 0.075 A (100 V)-0.045 A (240 V)
Rated Output:	4.2 V DC/0.5 A
Charging Time:	Approx. 130 minutes*
Operating Temperatures:	0-40 °C (32-104 °F)
Dimensions:	90.4 x 56.0 x 28.0 mm (3.6 x 2.2 x 1.1 in.)
Weight:	Approx. 78 g (2.8 oz.)

\* When charging Battery Pack NB-1LH

**Compact Power Adapter CA-PS500**

**(Included with the optional AC Adapter Kit ACK500)**

Rated Input:	100-240 V AC (50/60 Hz) 0.17 A
Rated Output:	4.3 V DC/1.5 A
Operating Temperatures:	0-40 °C (32-104 °F)
Dimensions:	42.6 x 104.4 x 31.4 mm (1.7 x 4.1 x 1.2 in.)
Weight:	Approx. 180 g (6.3 oz.)

**Car Battery Charger CBC-NB1 (Optional)**

Rated Input:	DC 12-24 V, 4.3 W
Rated Output:	4.2 V DC, 0.55 A
Charging Time:	Approx. 130 minutes*
Operating Temperatures:	0-40°C (32-104°F)
Dimensions:	90.4 x 56.0 x 28.0 mm (3.6 x 2.2 x 1.1 in.)
Weight:	Approx. 106 g (3.7 oz.)

\* When charging Battery Pack NB-1LH

# Index

## A

AC Adapter Kit (ACK500) 141  
 AE Lock 66  
 AF Frame 32, 68  
 AF-assist Beam 36  
 AF Lock 64  
 AiAF 34  
 Autofocus 34, 68  
 Autofocus Lock 64  
 Auto Mode 49  
 Auto Power Down 27  
 Auto Rotate 78  
 AV Cable AVC-DC100 121

## B

Battery  
 Battery Pack Charge 18  
 Capacity 150  
 Handling 19  
 Installing 20  
 Recharging 18  
 Battery Pack 18

## C

Care and Maintenance 143  
 CF Card  
 Capacities 151  
 Formatting 97  
 Handling 23  
 Installing 22  
 Car Battery Charger 142  
 Compression 51  
 Continuous Shooting 57  
 Custom White Balance 74

## D

Date/Time 23  
 DIGITAL Terminal 103, 104, 123  
 Digital Zoom 37  
 Direct Interface Cable  
 DIF-100 103

Connecting to a Bubble Jet  
 Printer 103  
 Direct Print function Compatible  
 Printer 102  
 Direct Printing 99  
 DPOF 99, 100, 111, 119  
 DPOF Print Order 99  
 Printing 111  
 Print Style 114  
 Resetting 116  
 Selecting Images 111  
 DPOF Transfer Order 119  
 Downloading Images to a Computer  
 122

## E

Erasing  
 All Images 96  
 Single Images 95  
 Exposure 66, 70

## F

FE Lock 67  
 File Number 79  
 File Sizes 151  
 Flash 53  
 Focus Lock 64  
 Formatting 97  
 Functions Available in Each Shooting  
 Mode 160

## H

Histogram 33

## I

Image File Sizes 151  
 Index Replay 82  
 Indicator 17  
 ISO Speed 77

**L**

- Language 25
- LCD Monitor
  - Information Displayed 31
  - Using the LCD Monitor 29

**M**

- Macro Mode 55
- Magnifying 81
- Manual Mode 49
- Menu
  - Play 129
  - Rec. 127
  - Set up 130
- Messages
  - List of Messages 137
  - List of Messages Displayed while
    - Direct Print Function Compatible Bubble Jet Printer is Connected 140
  - List of Messages Displayed while
    - Direct Print Function Compatible Printer is Connected (CP series) 139
- Metering Modes 69
- Mode Switch 16, 28
- Movie
  - Movie Mode 62, 83
  - Replaying 80
  - Editing 85
- My Camera Menu
  - Changing 45
  - File Format 48
  - Registering 46
- My Camera Settings 45

**O**

- On/Off Button 26

**P**

- Photo Effect 76
- Play Menu 129
- Power On/Off 26
- Power Lamp 16
- Power Save 27
- Print Settings (Direct Print Printers)

- Number of Print Copies 107
- Print Area (Trimming) 109
- Print Style 107
- Selecting Images 105

- Protect 94

**R**

- Rec. Menu 127
- Red-Eye Reduction Function 54
- Replay Mode 30
- Resolution 51
- Review Duration 50
- Rotate 87

**S**

- Self-Timer 58
- Set up Menu 130
- Shooting Mode 28, 49
- Shooting Mode Dial 49
- Shutter Button 35
  - Pressing Fully 36
  - Pressing Halfway 35
- Shutter Speed 71
- Single Image Replay 80
- Slide Show 90
  - Play Time 93
  - Repeat Settings 93
- Spot AE Point Frame 32, 69
- Stitch Assist Mode 59

**T**

- Telephoto 37

**U**

- USB Cable 123

**V**

- Video Output System 121
- Viewfinder 34
- Viewing
  - Single Image Replay 80
  - Index Replay 82

**W**

- White Balance 73
- Wide Angle 37
- Wrist Strap 15

**Disclaimer**

- While every effort has been made to ensure that the information contained in this guide is accurate and complete, no liability can be accepted for any errors or omissions. Canon reserves the right to change the specifications of the hardware and software described herein at any time without prior notice.
- No part of this guide may be reproduced, transmitted, transcribed, stored in a retrieval system, or translated into any language in any form, by any means, without the prior written permission of Canon.
- Canon makes no warranties for damages resulting from corrupted or lost data due to a mistaken operation or malfunction of the camera, the software, the CompactFlash™ cards (CF cards), personal computers, peripheral devices, or use of non-Canon CF cards.

**Trademark Acknowledgments**

- Canon, PowerShot and Bubble Jet are trademarks of Canon, Inc.
- CompactFlash is a trademark of SanDisk Corporation.
- iBook and iMac are trademarks of Apple Computer, Inc.
- Macintosh, PowerBook, Power Macintosh and Quick Time are trademarks of Apple Computer, Inc., registered in the United States and other countries.
- Microsoft, Windows and Windows NT are either registered trademarks or trademarks of Microsoft Corporation in the United States and/or other countries.
- Other names and products not mentioned above may be registered trademarks or trademarks of their respective companies.

## FCC Notice

(Digital Camera, Model PC1038)

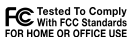

This device complies with Part 15 of the FCC Rules. Operation is subject to the following two conditions;

- (1) this device may not cause harmful interference, and
- (2) this device must accept any interference received, including interference that may cause undesired operation.

Note: This equipment has been tested and found to comply with the limits for Class B digital devices, pursuant to Part 15 of the FCC rules. These limits are designed to provide reasonable protection against harmful interference in a residential installation. This equipment generates, uses and can radiate radio frequency energy and, if not installed and used in accordance with the instructions, may cause harmful interference to radio communications. However, there is no guarantee that interference will not occur in a particular installation. If this equipment does cause harmful interference to radio or television reception, which can be determined by turning the equipment off and on, the user is encouraged to try to correct the interference by one or more of the following measures:

- Reorient or relocate the receiving antenna.
- Increase the separation between the equipment and receiver.
- Connect the equipment into an outlet on a circuit different from that to which the receiver is connected.
- Consult the dealer or an experienced radio/TV technician for help.

The cable with the ferrite core provided with the digital camera must be used with this equipment in order to comply with Class B limits in Subpart B of Part 15 of the FCC rules.

Do not make any changes or modifications to the equipment unless otherwise specified in the manual. If such changes or modifications should be made, you could be required to stop operation of the equipment.

Canon U.S.A. Inc.

One Canon Plaza, Lake Success, NY 11042, U.S.A.

Tel No. (516) 328-5600

## Canadian Radio Interference Regulations

THIS CLASS B DIGITAL APPARATUS MEETS ALL REQUIREMENTS OF THE CANADIAN INTERFERENCE CAUSING EQUIPMENT REGULATIONS.

## Réglementation canadienne sur les interférences radio

CET APPAREIL NUMERIQUE DE LA CLASSE B RESPECTE TOUTES LES EXIGENCES DU REGLEMENT SUR LE MATERIEL BROUILLEUR DU CANADA.





























MEMO







## MEMO

## Functions Available in Each Shooting Mode

The chart below is a reference for the settings available for various shooting conditions. The settings selected in each shooting mode are saved after you finish shooting.

Function		 Auto	 Manual	 Stitch Assist	 Movie	Reference Page
Resolution	Large	 ●*	●*	▲*	—	p. 51
	Medium 1	 ●	●	▲	—	p. 51
	Medium 2	 ●	●	▲	—	p. 51
	Small	 ●	●	▲	—	p. 51
	Movie	 —	—	—	●*	p. 51
	Movie	 —	—	—	●	p. 51
Compression	Superfine	 ●	●	▲	—	p. 51
	Fine	 ●*	●*	▲*	—	p. 51
	Normal	 ●	●	▲	—	p. 51
Flash	Auto	 ●	●	—	—	p. 53
	Red-Eye Reduction Auto	 ●*	●*	—	—	p. 53
	On	 —	●	▲	—	p. 53
	Off	 ●	●	▲*	●	p. 53
	Slow-Synchro	 —	●	▲	—	p. 53
Macro Mode	 ●	●	▲	●	p. 55	
Infinity Mode	 —	●	▲	●	p. 55	
Focus Lock	 —	●	—	—	p. 64	
AE Lock	 —	●	—	—	p. 66	
FE Lock	 —	●	—	—	p. 67	
Shooting Method	Single	 ●*	●*	▲*	●*	—
	Standard continuous shooting	 —	●	—	—	p. 57
	High-speed continuous shooting	 —	●	—	—	p. 57
	10-sec. self-timer	 ●	●	▲	●	p. 58
	2-sec. self-timer	 ●	●	▲	●	p. 58

Function		 Auto	 Manual	 Stitch Assist	 Movie	Reference Page
Autofocus Modes		–	●	–	–	p. 68
AF-assist Beam		●	●	▲	●	p. 36
Digital Zoom		●	●	–	–	p. 56
Exposure Compensation		–	●	▲	●	p. 70
Light Metering Method	Evaluative	–	●	–	–	p. 69
	Center-Weighted Averaging	–	●	–	–	p. 69
	Spot Metering	–	●	–	–	p. 69
Long Shutter		–	●	–	–	p. 71
White Balance		–	●	▲	●	p. 73
Photo Effect		–	●	▲	●	p. 76
ISO Speed		– <sup>(1)</sup>	●	– <sup>(1)</sup>	– <sup>(1)</sup>	p. 77
Auto Rotate		●	●	▲	–	p. 78

\* Default setting.

● Setting available.

▲ Setting can only be selected for the first image.

■ (Shaded Area): Setting is memorized even when the camera power is shut off.

<sup>(1)</sup> The ISO speed is automatically set.

With the exception of the [Date/Time], [Language] and [Video System] settings, all the other menu settings and changes made with the camera buttons can be reset to the default values in a single operation (p. 136).